

Introduction

The Ultra TT Automation Series System is a batch process, semi-automatic, time-pressure dispensing system with fully integrated closed-loop positioning functions. The system ensures repeatability in both critical positioning and timing operations, thus ensuring a more consistent fluid deposit and a higher quality product.

Please spend a few minutes to become familiar with this guide before operating your new Ultra TT system. Follow our recommended teaching and operating procedures. Use the template provided to help you create programs that incorporates different core dispensing functions. Review the helpful information we have included from over 30 years of industrial dispensing experience.

Most questions you will have are answered in this guide. However if you need further assistance, please do not hesitate to contact EFD[®] or your authorized distributor.

www.efd-inc.com/xyz
automation@efd-inc.com



US & Canada, call 800-556-3484

In Mexico, call 001-800-556-3484

In the UK, ring free 0800 585733

The EFD Pledge

We pledge that you will be completely satisfied with our products. We endeavor to ensure that every EFD product is produced to our no-compromise quality standards.

If you feel that you are not receiving all the support you require, or if you have any questions or comments, I invite you to write or call me personally.

Our goal is to build not only the finest equipment and components, but also to build long-term customer relationships founded on superb quality, service, value and trust.



Peter Lambert, President

plambert@efd-inc.com

+1 (401) 434-1680

CONTENTS

Safety

	Warnings	5-7
i.	Log-out Tag-out Procedures	7
ii.	Operator Hazard Training	8

Specifications

	Figure 1: Dimensions of Ultra 325TT	9-11
	Figure 2: Dimensions of Ultra 525TT	9-11

	Shipping Contents	12
--	-------------------------	----

	Warranty	12
--	----------------	----

1 Getting Started

1.1	System Features	13
	1.1.1 Front Panel	14
	1.1.2 Back Panel	15
1.2	Machine Movements	16
1.3	A Typical Operation	16

2 Setup

2.1	Preparing the work area	17
2.2	Main Air & Electrical	17
2.3	Mounting Work-holding Fixture	18
2.4	Connections on the Z-head	18-19
2.5	Mounting Valve or Syringe barrel	20
	2.5.1 Syringe barrel	21
	2.5.2 Single air input valve	22
	2.5.3 Multi air input valve	23
	2.5.4 Electric auger valve	24
2.6	Mounting Laser Pointer	25

3	PDA	26-27
---	-----------	-------

4 System Configuration

4.1	Valve Selection	28
	4.1.1 Valve #1	29
	4.1.1.1 Teaching Tip to Probe Offset	30
	4.1.2 Toggle Valve	31
	4.1.2.1 Configuring Toggle	31-32
4.2	Units	32
4.3	Height Sensor	33
4.4	Park Location	34
4.5	Purge Valve #1	34
4.6	Purge Toggle	35
4.7	Safe Z	35

5 Programming

5.1	Creating a New Program	36-37
5.2	Teaching Dispensing Points	37
5.3	Teaching a Dot	38

5.4	Teaching a Continuous Path	39
5.4.1	CP Line	39-40
5.4.2	Arc	40-41
5.4.3	Circle	41
5.4.4	Irregular Continuous Path	42
5.5	Height Sense	42-43
5.6	Stepping & Repeating (Regular Intervals)	44-45
5.7	Inserting a DO Program Instruction	45-46
5.8	Inserting an OUTPUT Instruction	47
5.9	Executing a Download	48
6	Operational Features	
6.1	Downloading a Program	49
6.2	Running a Program	49
6.3	Deleting a Program	50
6.4	Renaming a Program	50
6.5	Copying a Program (Save As)	51
6.6	Inserting/Deleting Points in a Program	51
6.7	Changing Program ID#	52
6.8	Changing Program Origin	52
6.9	Editing Functions	53
6.9.1	Deleting instruction line(s) from a program	53
6.9.2	Copying instruction line(s) to a new program	53
7	Interactive LCD Panel	
7.1	Power Up	54
7.2	Loading a Program	55
7.3	Running a Program	55-56
7.4	Tip Offset/Relocate	56
7.5	Height Sensor Z-offset	57
7.6	Valve Purge	57
8	Accessories	58
9	I/O	59
10	Preventative Maintenance	
10.1	Cleaning	59
10.2	Preventative Maintenance	59-60
10.3	Spare Parts List	61
10.4	Disposal	61
11	Troubleshooting	62-65
APPENDICES		
A	Jogging Your Machine	66-67
B	Teaching Template	68
C	Program Origin	69
D	Dot Parameters Explained	70-71
E	Line Parameters Explained	72-74
F	Technical Request Form	75-76
G	Electrical Block Diagrams	77
H	Pneumatic Block Diagrams	78
GLOSSARY OF TERMS		79

SAFETY

- Read and understand this User's Guide and all safety labels before operating this machine.
- Only a trained person is to be permitted to operate this machine. Training should include instructions in operation under normal conditions and emergency situations.
- This machine is to be serviced only by trained and authorized personnel. Lockout procedures should be strictly followed before servicing.
- Never reach into the machine for any reason unless the machine is at a COMPLETE STOP.
- Never leave the machine stopped in such a manner that another worker can start the machine while you are working on or within the machine.
- Never change or defeat the function of electrical interlocks or other machine "shutdown" switches.
- Before starting this machine, check that:
 - All persons are clear of the machine
 - No maintenance work is being performed on the machine
 - All guards are in place
 - The machine is free of paper scraps, wraps and jams.
- There is a potential hazard of entanglement in this machine caused by items such as long hair, loose clothing, and jewelry. Make sure your clothing and hair fit closely to your body and that all jewelry, rings and watches are removed while working on the machine.

WARNINGS



The Ultra TT Series is designed for semi-automated fluid dispensing onto assembly parts. Users should always use appropriate personal protective gear as indicated by fluid manufacturer.



This product is heavy and should only be moved with assistance. Always follow safe lifting practices and lift with your legs, not your back. Handles can be attached to the machine's T-slots located on the side of the machine. This will provide for a more secure grip when moving the machine.



Remove shipping bolt (located at the top right-hand corner of the Z-plate) before operating the machine. Failure to do so may result in machine damage.



Never place your hand beneath the dispensing tip or any moving actuator during operation, as automatic movement can occur and may cause serious personal injury.



Please read all safety warnings prior to handling equipment or the dispensing fluid. Equipment should be stored in a clean, dry environment, preferably in original shipping container.



This machine emits a maximum of 63 dBA of noise from the rear of the machine. Note that this is well within safe noise levels for operators.



Never move or ship the unit with the tooling plate attached to the Y-Axis. The added weight will cause damage during shipment! All axes must be secured in place prior to shipping. Not doing so will cause damage to the equipment.



Provide maintenance in strict compliance with procedures set forth in this guide. Never try to perform maintenance on a machine while it is running. Doing so could cause serious injury.



Periodic preventive maintenance will be required.

- 1. Annually, apply a light coat of grease on the cable and linear motion guides.*
- 2. Cables should also be tensioned on an annual basis.*

See Section 10 for details



All positive pneumatic energy is removed from the system at both power-down (turning off the main circuit breaker) and during EMO (Emergency Machine Off) conditions. The Ultra TT maintains a vacuum in order to hold a column of fluid inside EFD barrel syringes. This is designed as a safeguard to prevent low viscosity fluid from being discharged at power-down or during EMO conditions.



Laser-equipped Ultra TT system is classified as a Class II laser product. Please attach the appropriate warning label that is shipped with your laser module onto the machine. The warning label should read “LASER RADIATION PRESENT. DO NOT STARE INTO BEAM”.

RoHS标准相关声明 (China RoHS Hazardous Material Declaration)

产品名称 Part Name	有害物质及元素 Toxic or Hazardous Substances and Elements					
	铅 Lead (Pb)	汞 Mercury (Hg)	镉 Cadmium (Cd)	六价铬 Hexavalent Chromium (Cr6)	多溴联苯 Polybrominated Biphenyls (PBB)	多溴联苯醚 Polybrominated Diphenyl Ethers (PBDE)
外部电子连接点 All Brass Fittings	X	0	0	0	0	0
<p>0: 表示该产品所含有的危险成分或有害物质含量依照EIP-A, EIP-B, EIP-C的标准低于SJ/T11363-2006 限定要求。 0: Indicates that this toxic or hazardous substance contained in all the homogeneous materials for this part, according to EIP-A, EIP-B, EIP-C is below the limit requirement in SJ/T11363-2006.</p> <p>X: 表示该产品所含有的危险成分或有害物质含量依照EIP-A, EIP-B, EIP-C的标准高于SJ/T11363-2006 限定要求。 X: Indicates that this toxic or hazardous substance contained in all the homogeneous materials for this part, according to EIP-A, EIP-B, EIP-C is above the limit requirement in SJ/T11363-2006.</p>						



WARNING! There are several pinch points (indicated with yellow hazard stickers) on this machine that should be avoided. Failure to do so while the machine is operating may cause serious injury.

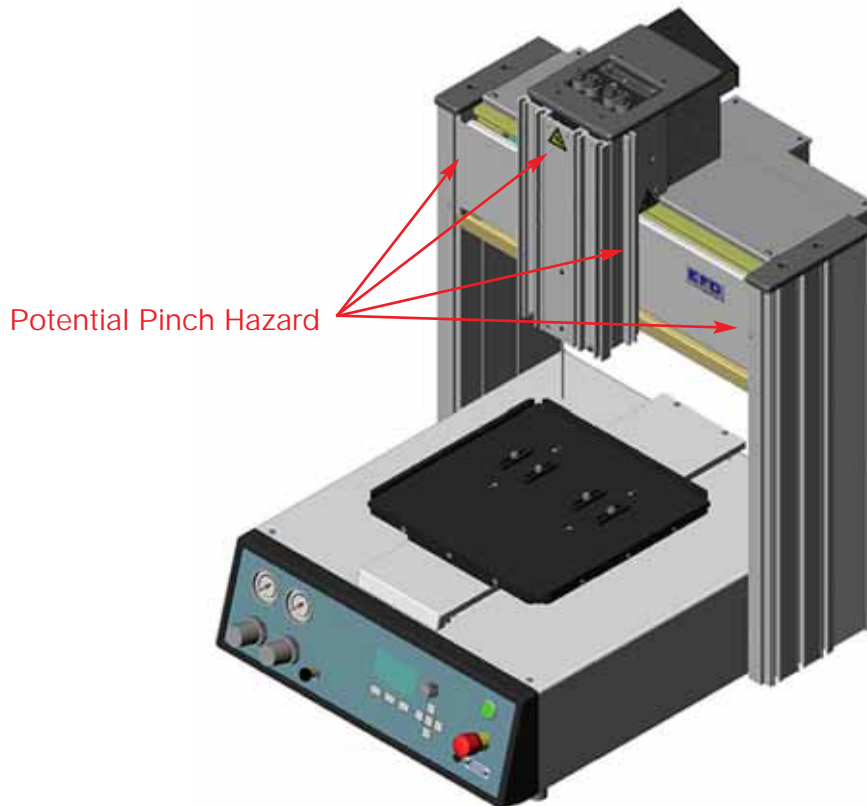

i. LOCK-OUT TAG-OUT PROCEDURE



1. Announce lockout to other personnel.
2. Verify that all dispensing motion has stopped.
3. Turn power OFF at main power circuit breaker at the back of the Ultra TT
4. Disconnect the power cord from the electrical source. Place the power cord in a location where it can be seen at all time during the maintenance or service.
5. Place a warning tag on the Main Power Inlet.
6. Turn the shut-off valve for the pneumatic circuit to the OFF position
7. Lockout power in OFF position.
8. Put key (if any) in pocket.
9. Clear machine of all personnel.
10. Test lockout by hitting RUN button.

11. Block, chain or release stored energy sources.
12. Always unplug the machine and disconnect the main airline to the system before opening any panels for service. Once the machine has been disconnected from power and air, the electric cord and airline must remain in sight of the individual performing maintenance. This is to prevent accidental start-up of any energy sources.

ii. OPERATOR HAZARD TRAINING

Operators and technicians should know the closest location of the following safety related items in your facility:

- Emergency Exits
- Emergency Telephone
- Eye-Wash Station
- Fire Extinguisher
- First Aid Station
- MSDS Station

In the event of an emergency or malfunction, press the Emergency Machine Off (EMO) button. The EMO is the large red button located on the front panel of the dispensing system. Activating the EMO vents all pressure in the pneumatic system, de-energizes the servo power supply capacitors, and cuts power to all components. As a minimum, activate the EMO in the following situations:

1. If anyone is in immediate danger of being injured by moving parts, hazardous materials, or electrical shock.
2. If valuable dispensing system components or the work-pieces are in danger of being damaged. This can include:
 - Physical damage to the dispensing valve or work-piece by unexpected Dispensing Head movement.
 - Electrical damage to the dispensing system.

If an injury occurs during operation or servicing of the System, it is recommended that the following steps be taken:

1. If the dispensing system is operating when the injury occurs, press the nearest EMO button to stop all system operations.
2. Immediately report injury to supervisor in accordance with facility procedures.
3. If it is an injury due to exposure to a hazardous material, refer to the treat recommendations on the material manufacturer's Material Safety Data Sheet (MSDS).
4. Seek medical help if necessary.

SPECIFICATIONS

	Ultra 325TT	Ultra 525TT
Work Area	325 x 325 x 100	525 x 525 x 100
Resolution (μm)	10	10
Repeatability (μm)	25	25
Max Speed (mm/sec)	500	500
Acceleration	0.25g	0.25g
Mechanical Configuration	H-Bridge De-coupled Axes	H-Bridge De-coupled Axes
Control Method	Closed Loop DC Servo	Closed Loop DC Servo
Drive System	Cable Drive	Cable Drive
Foot Print (mm) Width x Depth x Height	560 x 670 x 750	760 x 850 x 750
Weight (Kg)	45	70
Tool Payload (Kg)	5	5
Workpiece Payload (Kg)	10	10
Programming Interface	Front Panel Buttons PDA™ Handheld	Front Panel Buttons PDA Handheld
Program Capacity	100	100
Point Capacity	10,000	10,000
General Purpose I/O	16 Inputs / 16 Outputs	16 Inputs / 16 Outputs
Discrete I/O	1 Analog Input/Output 2 (Sink/Source) Inputs 2 (Sink/Source) Outputs 2 Solenoid Drivers	1 Analog Input/Output 2 (Sink/Source) Inputs 2 (Sink/Source) Outputs 2 Solenoid Drivers
External Communications	1 RS232 / 1 PDA	1 RS232 / 1 PDA
Height Sensor	Yes (Standard)	Yes (Standard)
Software Compatibility	Palm OS™/ ACL ¹	Palm OS/ ACL
Max Power Consumption	320 Watts	320 Watts
Input Voltage	100VAC~240VAC ($\pm 10\%$)	100VAC~240VAC ($\pm 10\%$)
Dispense Controller	Integrated	Integrated
No. of Dispense Valves/Barrels ²	1, 2 or 3	1, 2 or 3
Patterns	Lines, Circles, Arcs Continuous Paths Potting and Dots	Lines, Circles, Arcs Continuous Paths Potting and Dots
Dot/Line types	10 Dot / 10 Line per Program	10 Dot / 10 Line per Program
Front Panel Control	Offsets, Jogging & Program Select	Offset, Jogging & Program Select



¹ Automove Command Language.

² One (1) integrated control only.

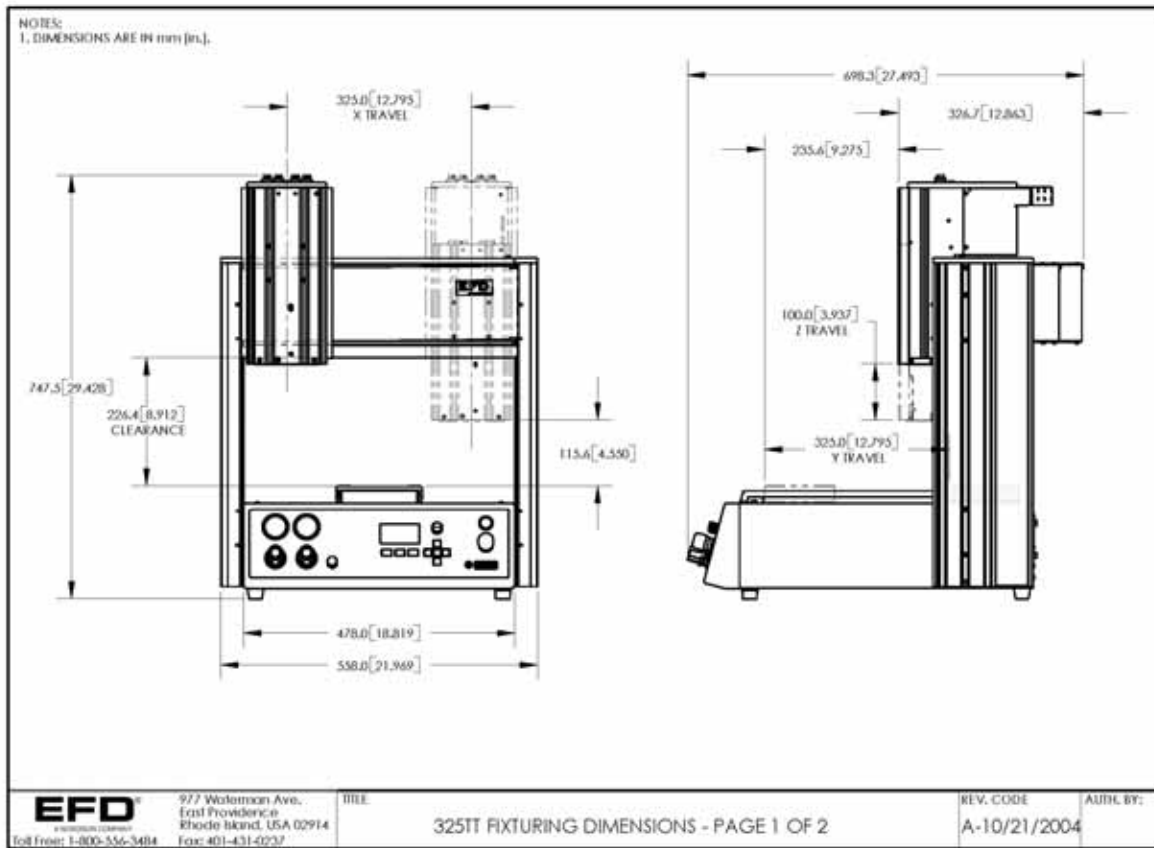

THIS DRAWING IS FOR THE EXPRESS AND SOLE USE OF EFD SALES, ALL RIGHTS RESERVED. © 2004 EFD INC. www.efd-inc.com

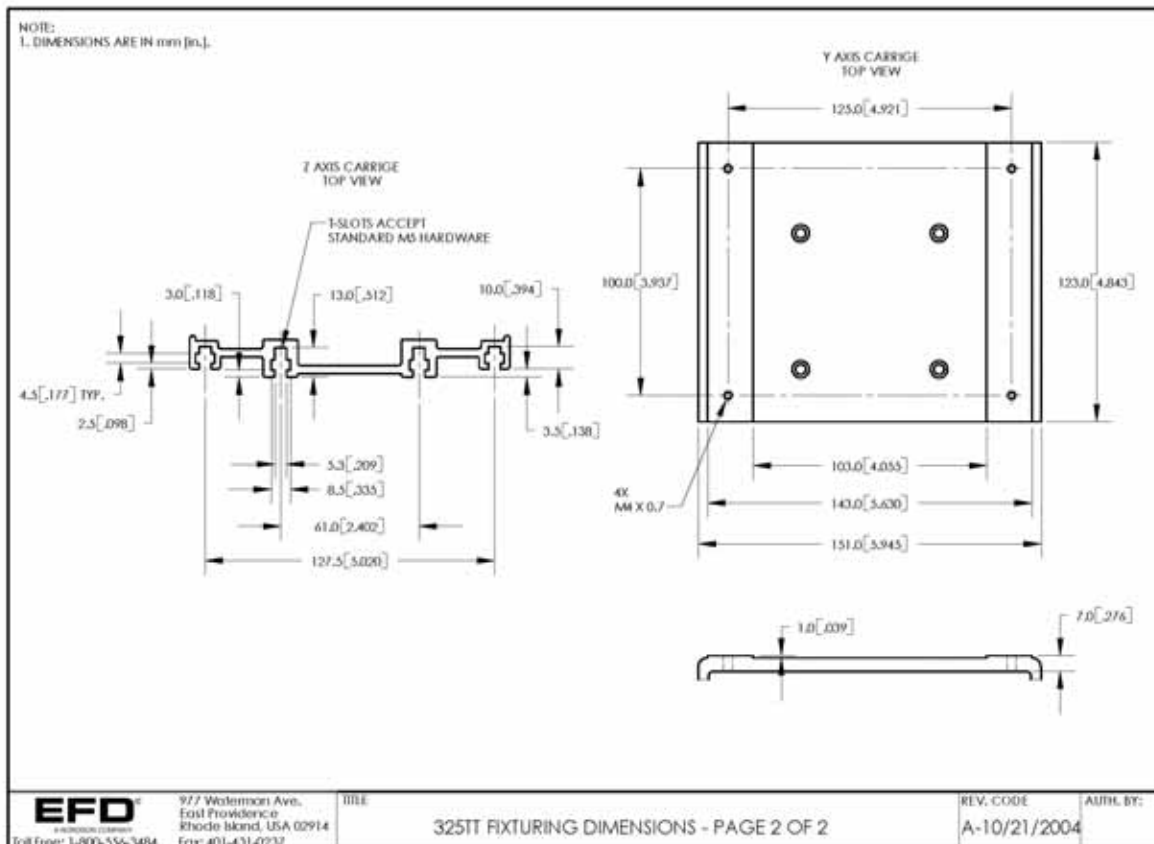

THIS DRAWING IS FOR THE EXPRESS AND SOLE USE OF EFD SALES, ALL RIGHTS RESERVED. © 2004 EFD INC. www.efd-inc.com

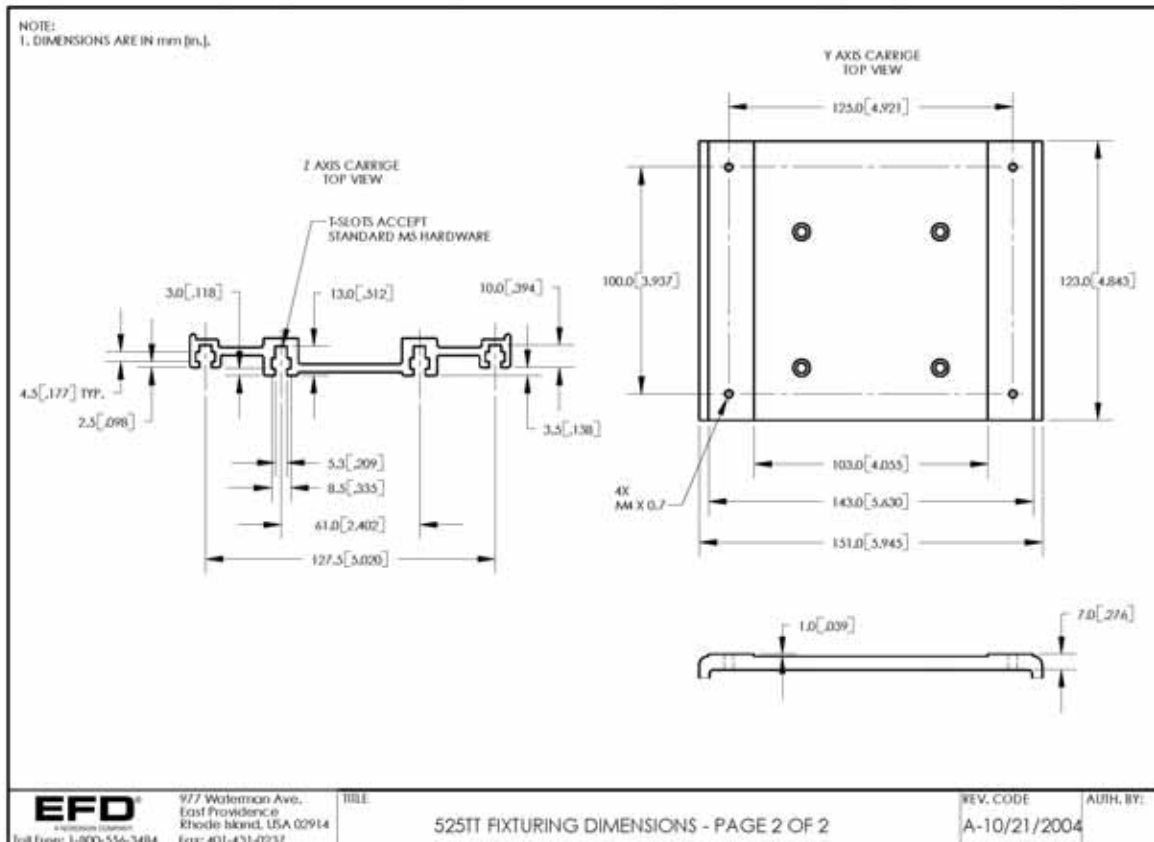
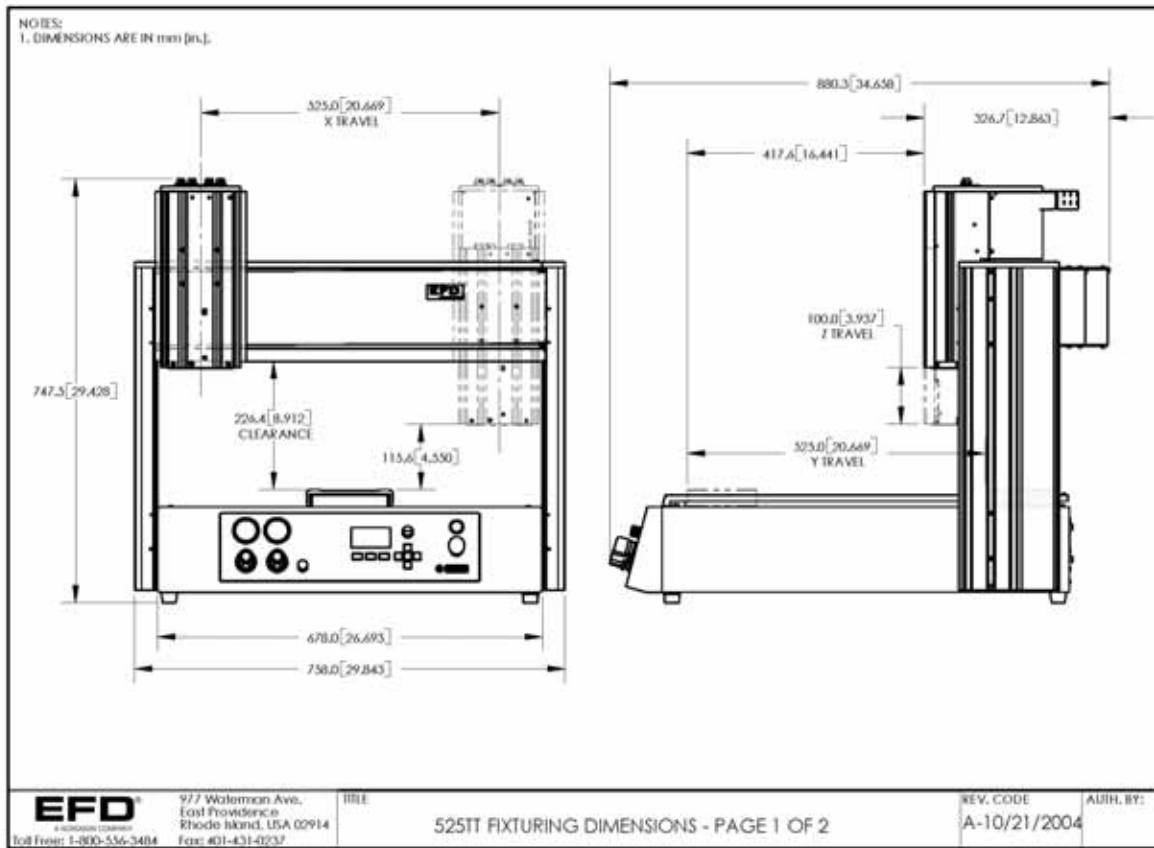

SHIPPING CONTENTS

Your System is shipped with the following:

- (1) Ultra TT Automation Series system
- (2) Power cords; one for 110VAC, one for 230VAC
- (1) Z-head counter-balance spring³
- (1) User Operation & PDA Software CD Rom
- (1) Quick Start Installation Guide, Warranty Card, Complaint Card
- (1) Socket™ Cordless Bluetooth® Adapter
- (1) Palm handheld⁴ (may be shipped separately)
- (1) Calibration Restoration mini-disk (adhered to the back of the X-cover)

Other EFD mounting and dispensing equipment, and accessories may also be included.

Note: In order to program and operate your Ultra TT automation system, you will need the following in addition to the above:

- Tooling plate
- EFD dispensing valve/syringe barrel
- Corresponding EFD valve/syringe barrel custom mounting bracket

WARRANTY

Your warranty information and return policy guideline is included in your shipment. Be sure to register your warranty within 30 days of your purchase. You can also register your warranty online through <http://www.efd-inc.com/warranty/xyz>. *Only registered users are eligible and notified of free upgrades.*

Note that the Palm™ handheld is not covered under the EFD Ultra TT warranty program. Please be sure to return the warranty card that accompanied your Palm handheld to Palm Corporation.

Within the period of the warranty, EFD will repair or replace any defective component, or the entire system at EFD's option, on authorized return of the part or complete system prepaid to the factory.

In no event shall any liability or obligation of EFD arising from this warranty exceed the purchase price of the equipment. Before using, user shall determine the suitability of the product for his intended use, and user assumes all risk and liability whatsoever in connection therewith. This warranty is valid only when clean, dry, filtered air is used.

EFD makes no warranty of merchantability or fitness for a particular purpose. In no event shall EFD be liable for incidental or consequential damages.

³ If the Z-axis needs to hold more than 3kg, then a second spring will be required. The Ultra TT System comes standard with only one spring installed.

⁴ User may also use their own PDA handheld, Palm OS 4.0 or higher, Bluetooth compatible.

1 GETTING STARTED

1.1 SYSTEM FEATURES

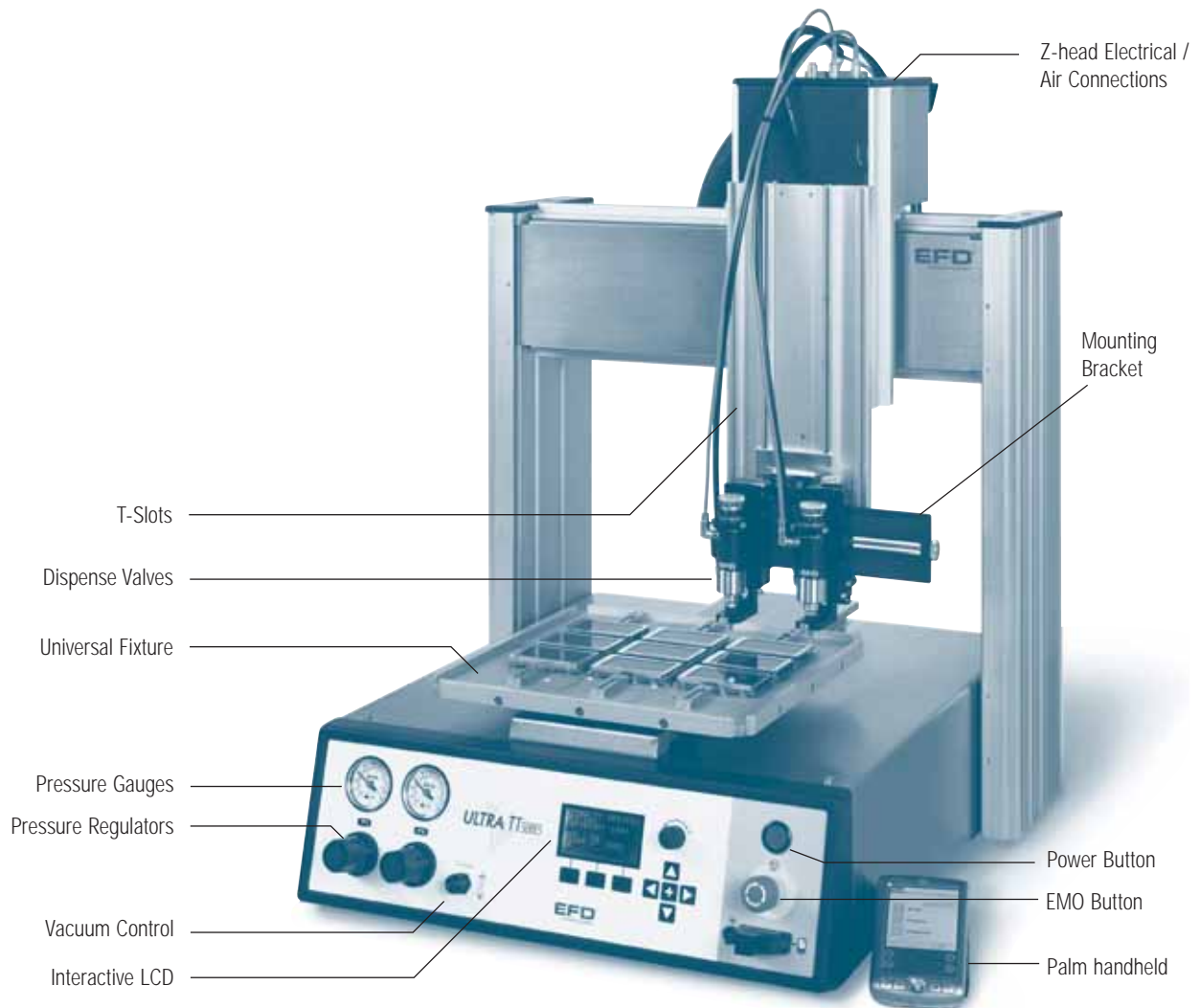

1.1.1 FRONT PANEL

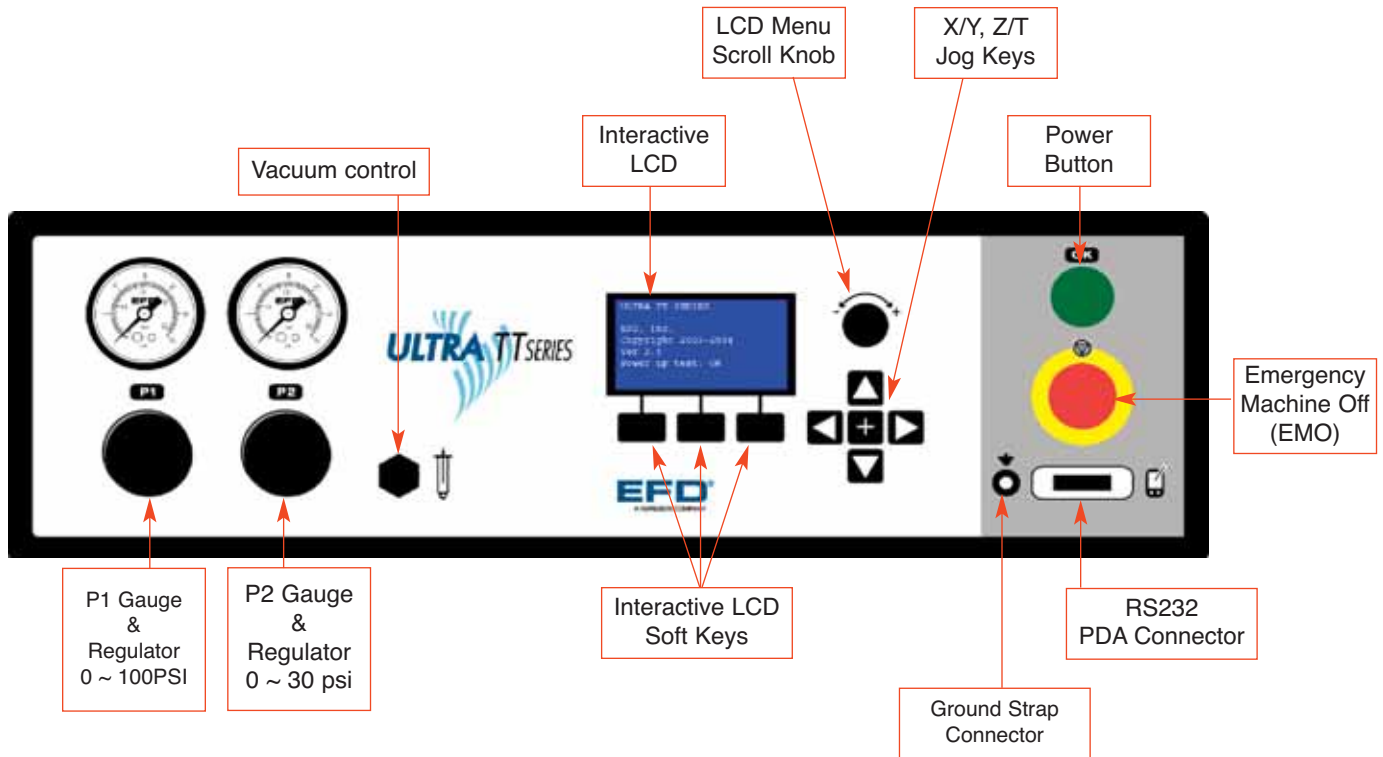

P1: 0-100 psi pneumatic channel. To adjust the pressure, first unlock the pressure knob by pulling outward, turn it to the right to increase pressure or left to reduce pressure. Push the knob inward to lock.

P2: 0-30 psi pneumatic channel. To adjust the pressure, first unlock the pressure knob by pulling outward, turn it to the right to increase pressure or left to reduce pressure. Push the knob inward to lock.

Vacuum control: The vacuum is connected in parallel so both P1 & P2 channels can maintain a vacuum. To adjust the vacuum pressure, turn the control knob to the left to increase vacuum and turn it right to decrease vacuum.

Interactive LCD: This is where you can view the current program selected, call up new programs, run tip offsets or purge routines, pause or resume a program. The LCD also outputs user-defined messages along with error messages. The arrow keys: X/Y, Z/T keys work in conjunction with the LCD that prompts the user to either teach current position or teach new position for tip location at origin. The keys are selectable between XY and ZT modes.

E-Stop: The large red button with the yellow indicator shuts off power to all actuating devices such as servomotors and pneumatic circuits. To reset power, you must turn the red button clockwise to release then press the green button to restore power to the actuator. This button should only be used for real emergency stops. If you want to abort a program, press the soft key directly beneath the word "abort" on the LCD panel.

1.1.2 BACK PANEL

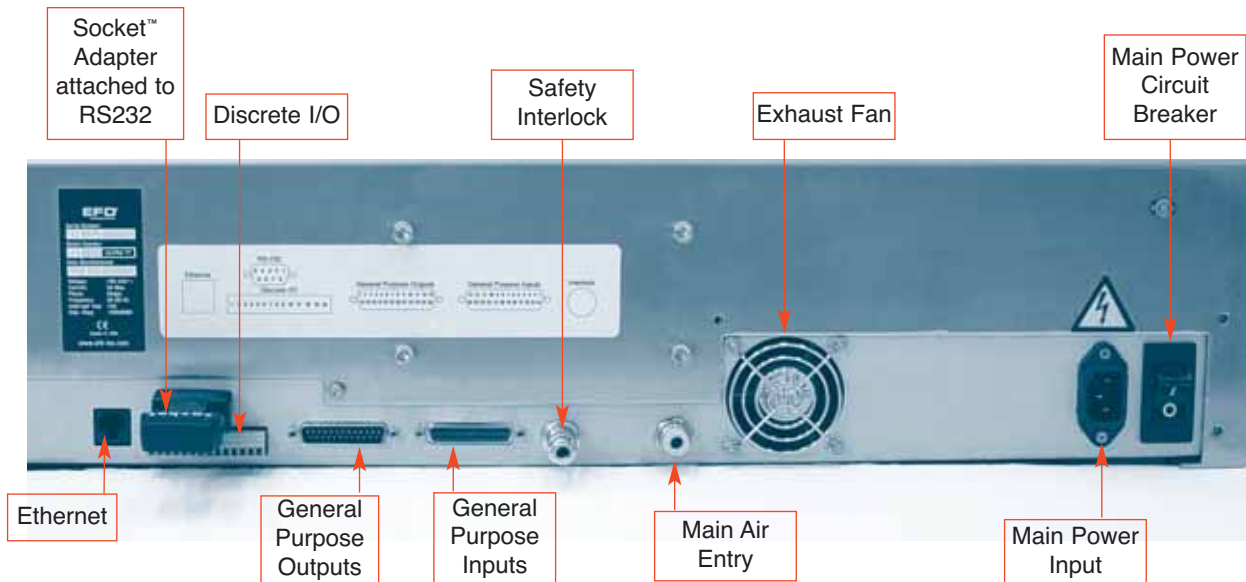

RS232: The RS232 port can be used to connect the Ultra TT System to a Computer or PDA. The Socket Bluetooth Adapter is connected here.

Discrete I/O: There are four digital I/Os, one analog I/O, and two 24VDC solenoid drivers. The Discrete I/Os are used in conjunction with the control of any dispensing options or devices that require a position reference within a program.

General Purpose Outputs: There are 16 General Purpose Outputs. They are either sinking or sourcing. The GP I/Os are used in conjunction with the control of any dispensing options or devices that require a timing reference within a program.

General Purpose Inputs: There are 16 General Purpose Inputs. The General Purpose Inputs are 24VDC, sink to ground. They are used in conjunction with the control of any dispensing options or devices that require a timing reference within a program.

Safety Interlock: If the Interlock signal is interrupted, the Interlock immediately stops all dispensing activity to protect the operator from injury.

Main Air Entry: This connects to the facility air supply. The Ultra TT System requires 85 l/min (1SCFM) maximum of clean, dry air (no oilers) delivered no more than 100 psi.

Main Power Input: The Main Power Input connects the dispensing system to the facility power supply. The Ultra TT System has an automatic sensing power supply integrated into the main power supply. It uses a main power supply between 100 Vac to 240 Vac (+/- 10%), 50-60 Hz.

Main Power Circuit Breaker: The Main Circuit Breaker is the main power switch for the System. It protects the System from facility power surges and controls the flow of facility AC power supplied to the Power manager.

1.2 MACHINE MOVEMENTS

The Ultra TT dispensing system uses an advanced microprocessor to simultaneously control three axes of motion. An optical encoder feedback system provides closed-loop control to accurately position the dispensing tip whether dispensing lines, dots or contoured paths.

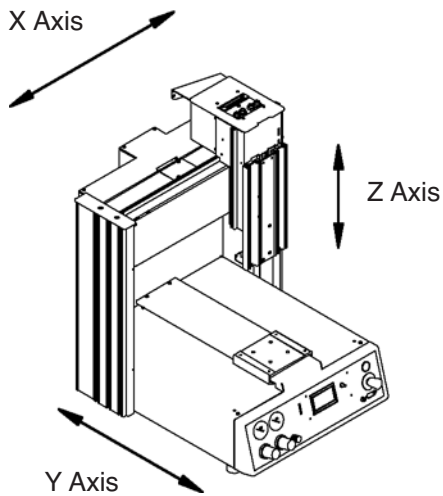

The Ultra TT Automation system is a three-axis fluid dispensing platform. The three degrees of freedom provided are X/Y/Z. The motions are indicated in the figure to the left.

The actual strokes of these axes vary depending on the model. The X-axis movement is side to side. The Y-axis movement is forward and backward, while the Z-axis movement is up and down. The mechanical home is determined by the location of each axes' home sensor. In the case of the Ultra TT, the home position is with the X-axis to the left, Y-axis to the back and Z-axis is up.

1.3 A TYPICAL OPERATION

A typical operation is described below. Note that setup and programming procedures are not included in the description.

- The part(s) is manually loaded and secured onto the tooling plate⁵.
- Operator activates the system by pressing the start button on the front of the machine.
- The dispensing head then moves to the programmed X/Y position and the height sensor probe is lowered to establish the correct dispense height based upon the dot or line parameter dispense gap. If the height sensor is disabled, then the dispensing head simply moves to the preprogrammed dispense height.
- Fluid is dispensed onto the part, according to the pre-programmed dispensing pattern.
- Once the dispensing procedure is complete, the dispensing head will move back to its preprogrammed park location.
- When the tooling plate returns to the park location, the completed part can now be removed from the tooling plate.
- The process is then repeated.

⁵ Purchased from EFD or User to supply their own.

2 Setup

2.1 Preparing the Work Area

Place the Ultra TT system on a stable table or bench. The Ultra TT needs enough space behind the machine (at least 250mm) to allow for the tooling to move to its home position. This space also ensures the fan duct on the back of the machine is not obstructed and thereby allows for air-cooling of the internal electronics.

Allow enough room to place fluid reservoir pressure tank beside the machine. Fluid cartridges may be mounted to the uprights using the M8 T-Slots on either side of the Ultra TT.

2.2 Main Air and Electrical

It is important that you have dry, clean filtered air that is aerosol free to prevent problems with the pneumatic system of your new Ultra TT system. Input air should not be more than 100 psi. If you have any doubts about your air supply, you should purchase one of the two filter regulator sets listed below.



2000F755TT Five-micron filter regulator
Order this if you do not have dry clean filtered factory air supply



2000F756TT Five-micron filter regulator
with coalescing filter to remove aerosols from air supply

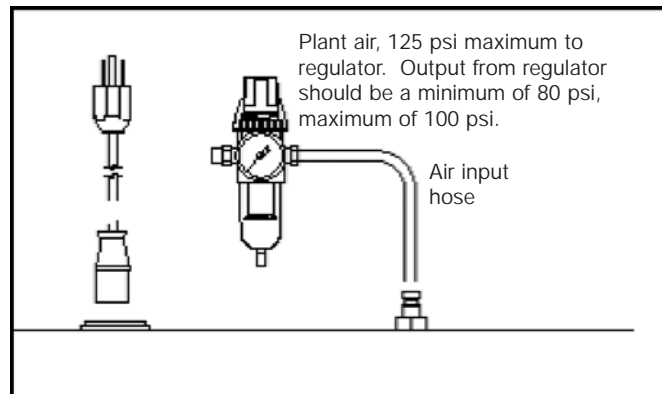

Main air input is located immediately to the left of the Fan Duct on the back panel of the machine and accepts 6mm diameter tubing. Simply push the 6mm tubing into the push-fit connector.

Each unit is shipped with two power cords. Plug the appropriate power cord into the three-prong power cord slot located on the back of the machine next to the main power circuit breaker. The machine is equipped with a self-regulating power supply and will accept 100VAC ~ 240VAC +/- 10%, 50 ~ 60 Hz input voltage.

2.3 MOUNTING WORK-HOLDING FIXTURE

Use the four tapped (4) M4 holes on the Y-Carriage to mount your work-holding fixtures.

It is important your work-holding fixture is mounted on the Y-carriage in a manner that it is parallel to the X-beam. Flatness of your fixture is important because it makes programming much easier. The Ultra TT system is 3D-capable and can be programmed to compensate for changes in Z-Height over the work envelope with the use of the built-in height sensor. However, invoking the built-in height sensor continuously through a dispensing program will significantly reduce throughput.

EFD offers two versions of fixture plates that can be used with the Ultra TT system. When dispensing onto low profile parts, it may be necessary to raise the fixture plate up so that the part(s) is within reach of the dispense valve. Refer to Section 9 (Accessories) for more information.

2.4 CONNECTIONS ON THE Z-HEAD



P1 quick-connect is connected to the 100 psi channel used for valve actuation and thicker fluids when using an EFD barrel reservoir. Line pressure is adjusted using the regulator marked P1 on the front panel.

P1 pressure on the front panel should be set to 70 psi when using any EFD air-actuated valve.

P2 quick-connect is connected into the 30 psi channel used for valve nozzle air on dual input valves and lower viscosity fluids when using an EFD barrel. Line pressure is adjusted by using the regulator marked P2 on the front panel.

When using a single air input valve, the P2 channel can be used to adjust the fluid pressure reservoir if 30 psi is sufficient. If you require more than 30 psi of fluid pressure, in situations where higher viscosity materials are used, use the Aux Air connection instead.

Aux Air quick-connect is usually used to supply fluid pressure. It is connected to the E-stop circuit. Fluid pressure will drop to 0 psi during emergency stop situations. Resetting the E-Stop switch and initializing the machine will return fluid pressure to normal.

To regulate to the required pressure for a barrel-supplied valve for pressures in excess of 30 psi, use EFD barrel pressure regulator kit (P/N 1117HTT) that attaches to the Z head with special mounting hardware and connects to Aux Air.

Terminal Block	Pin No	Function
4 Pos	1	790 Valve (+)
4 Pos	2	790 Valve (-)
4 Pos	3	24VDC (+)
4 Pos	4	Spare
Terminal Block	Pin No	Function
7 Pos	6	5VDC (+) (red)
7 Pos	7	HS Touch (green)
7 Pos	8	GND (black)
7 Pos	9	Laser Drive (blue)
7 Pos	10	24VDC (+)
7 Pos	11	Aux Sensor
7 Pos	12	Spare

The terminal blocks located on top of the Z-Head provide the connections needed to drive Auger valves, height sensors, laser pointers and auxiliary sensors.

Note: The height sensor has been pre-wired for your convenience.

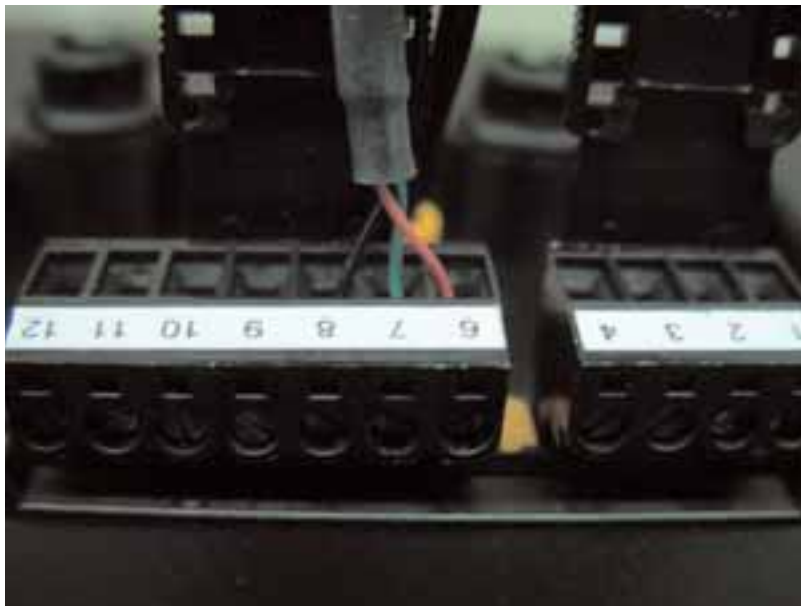

2.5 VALVE/SYRINGE BARREL CONNECTIONS

The following chart summarizes how different EFD valves/syringe barrels should be connected to the Z-head. Note that if more than one valve/syringe barrel is required for the application, a separate dispenser controller for each addition will be required.

The Ultra TT system is a self-contained fluid-dispensing positioning system. It features integrated dispensing functions to operate any EFD valve or syringe barrel. The valve/syringe barrel attaches to the Z-carriage with the appropriate mounting fixture, and all pneumatic lines plug into the EFD quick-connect on the top of the Z-head.

Note: Your deposit size has a direct correlation to fluid pressure, time, tip size, dispense gap and dispense speeds. To get desired results, you may need to experiment with different tip sizes, dispense gaps, pressures and speeds.

It is important to review the material specification sheet of the fluid to be dispensed and ensure that the proper personal protection equipment (such as footwear, gloves, etc.) is used with the type of fluid dispensed.

The following chart summarizes how different EFD valves/syringe barrels should be connected to the Z-head. Note that if more than one valve/syringe barrel is required for the application, a separate dispenser controller for each addition will be required.

EFD Dispensing Valve/Syringe barrel	Air Connection (actuating)	Air Connection (atomizing)	Fluid Pressure Connection
752V-UHSS	P1	N/A	P2 or Auxiliary Air
725DA-SS	P1	N/A	P2 or Auxiliary Air
725HF-SS	P1	N/A	P2 or Auxiliary Air
740V-SS	P1	N/A	P2 or Auxiliary Air
736HPA	P1	N/A	P2, Auxiliary Air or customer supplied
780S-SS	P1	P2	Auxiliary Air
790	Terminal 1+ Terminal 2 -	N/A N/A	P2 Selectable between pulsed or constant pressure
Syringe barrel 0~100 psi	P1	N/A	Same as actuating
Syringe barrel 0 ~ 30 psi	P2	N/A	Same as actuating
5800MP	P1	N/A	Same as actuating
HP4X™	P1	N/A	Same as actuating
HP7X™	P1	N/A	Same as actuating
2800	N/A	N/A	N/A

2.5.1 SYRINGE BARREL

This section also applies to EFD dispensing valves 5800MP, HP4X, and HP7X, in addition to EFD's range of syringe barrels.

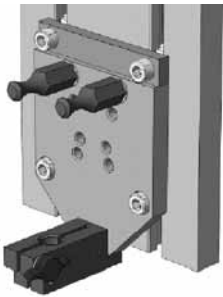

First, install the appropriate bracket e.g. universal syringe barrel bracket (P/N 700814) for syringe barrel installations, onto the Z-carriage. Insert the holding pins into the holes on the back plate to fit the size syringe barrel you are using. Insert the luer end of the syringe barrel into the syringe barrel stop and twist the syringe barrel onto the disposable luer extender.

Attach the syringe barrel adapter to syringe barrel and plug the male quick-connect into the female quick-connect located on top of the Z-head labeled P1 (for high-viscosity fluid, 0-100 psi) or P2 (for low-viscosity fluid, 0-30 psi). Attach your dispensing tip to the bottom of the luer extender.

To adjust the vacuum for low-viscosity fluids, use the vacuum control knob located on the front panel. The vacuum control knob is connected in parallel to both P1 and P2 pneumatic circuits.

Tip: Use blue pistons when dispensing low-viscosity fluids from syringe barrels. Regulate main air pressure to 50 psi.

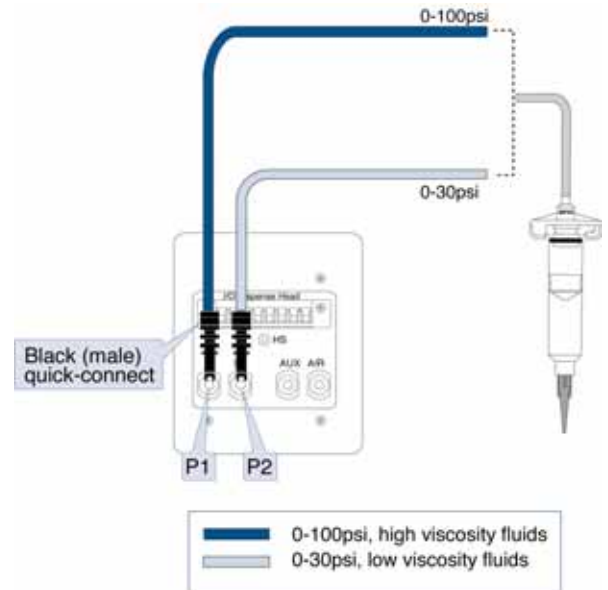

Adjust the height sensor probe so that it is clear from obstruction during your programmed routine. Be sure that you teach a new Z-Offset after adjustment of height sensor probe. Refer to the Quick Start Installation Guide on how to correctly adjust the height sensor probe.

2.5.2 SINGLE AIR INPUT VALVE

EFD's single-air input valves include 752V-UHSS, 725DA-SS, 725HF-SS, 740V-SS, and 736HPA.



Install the corresponding valve mounting fixture to the selected valve and then install the mounting fixture onto the Z-carriage. Refer to Section 8 (Ultra TT Accessories) for the entire list of EFD valve mounting fixtures.

Attach the pulsed-air line to the P1 connector on top of the Z-head. Fluid reservoir air is connected to P2, if required fluid pressure air does not exceed 30 psi. If more than 30 psi is required, use the Aux Air instead. The fluid reservoir tank should be placed to the side of the machine, or if using cartridges, attached to the T-slots on the Z-plate.

Note: Total weight on the Z-plate (including valve, valve mounting bracket and cartridge reservoir) should not exceed 5 kg. Ensure that you install the second spring (shipped with unit but not factory-installed) for loads greater than 3 kg.

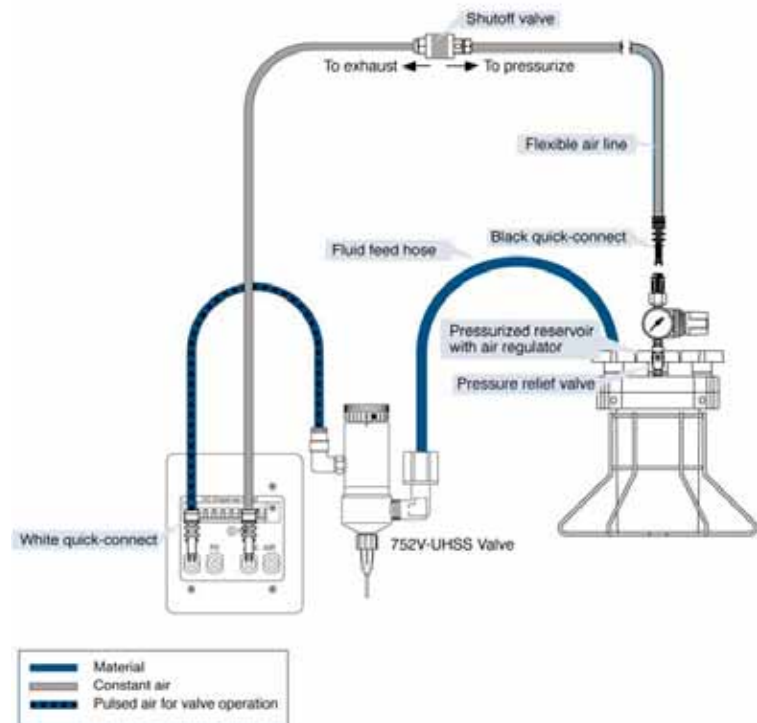

2.5.3 MULTI AIR INPUT VALVE

EFD's multi-air input valves include 780S-SS.



Install the corresponding valve mounting fixture to the selected valve and then install the mounting fixture onto the Z-carriage. Refer to Section 8 (Accessories) for the entire list of EFD valve mounting fixtures.

The pulsed air for valve operation plugs into the P1 connector on the Z-head. Set the air pressure on P1 Gauge/Regulator to 70 psi.

The pulsed nozzle air plugs into the P2 connector on the Z-head. Ensure the air pressure for P2 Gauge/Regulator is set to desired atomizing pressure.

The fluid reservoir supply air quick-connect plugs into Aux Air channel located on top of the Z-head.

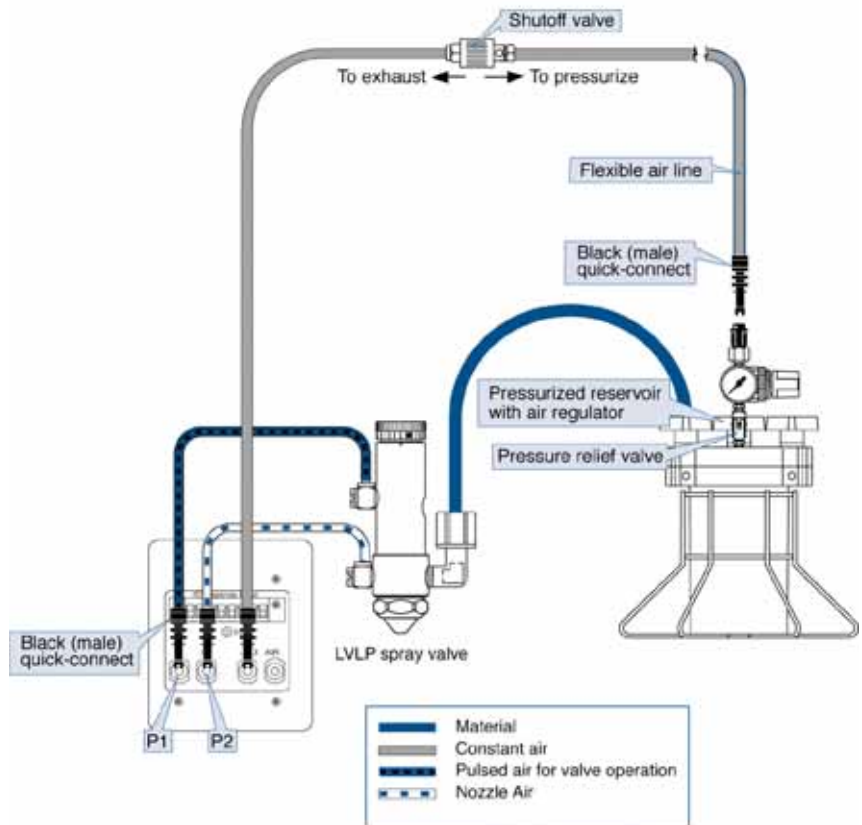

2.5.4 ELECTRIC AUGER VALVE



Install the Auger valve onto its corresponding valve bracket (P/N 700806) before attaching onto the T-slots of the Z-carriage.

The Auger valve uses a brushed DC motor and requires two electrical

connections into the 4-position terminal block located on top of the Z-Head. The positive (+) white wire goes to terminal 1 and the negative (-) brown wire goes into terminal 2.

If the white and brown wires are connected inversely, the motor will run in reverse. The Auger valve will not dispense fluid while the motor is running backwards. If the valve is not dispensing but the motor is turning, check fluid pressure and ensure the wires are plugged into the proper terminal.

The syringe barrel adapter quick-connects into the P2 connector on top of the Z-head. The fluid pressure can be set to pulse with the valve or remain constant. This setting is made in the valve setup (options window). The Ultra TT system also allows you to set parameters to turn off fluid pressure when the system is idle to prevent separation of solder paste.

The valve speed is selected as a voltage ranging from 10.0 VDC to 24 VDC in 0.1 VDC increments. This setting is made in the valve setup (options window). Maximum 250 RPM with a 400 RPM option (for 792 valve) are provided with either an 8 or 16 pitch auger. Once the voltage has been selected, the Back EMF circuit will maintain a constant RPM.

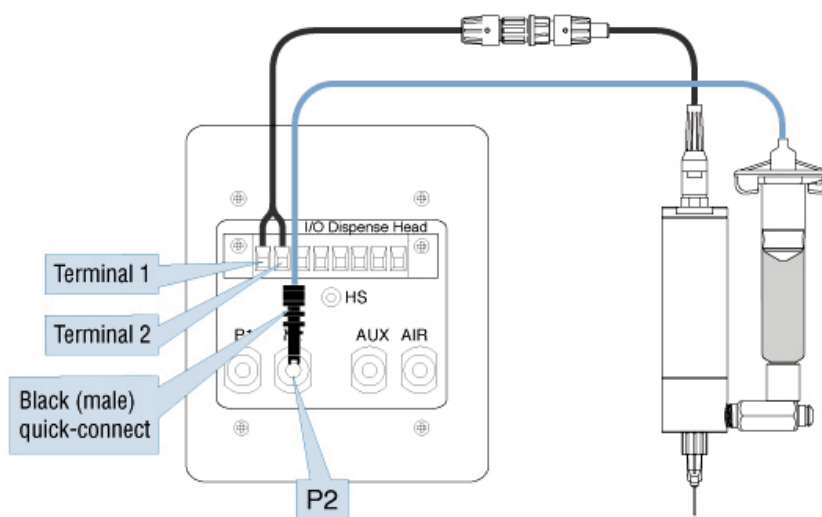

2.6 MOUNTING LASER POINTER

Some customers may prefer to use a laser pointer to aid in positioning the X or Y dispense programming points. Note that the laser pointer should be used in conjunction with the height sensor. The height sensor, along with the dot/line parameter setting of the “dispense gap” will determine the z-height at the dispense point. EFD provides a laser pointer and bracket (#700820) that can be easily mounted onto the Ultra TT.

To connect the optional laser pointer teaching device to the Ultra TT:

1. Secure the laser to the Z-head by sandwiching the laser bracket behind the syringe or valve bracket. Connect the laser pointer's red wire to terminal pin #6 (+5VDC power supply) on the Z-head connector and the blue wire to terminal #9.
2. Next, check the functionality of the laser.
 - a. Using the PDA, select “Program” from the “Main” screen.
 - b. Tap the top left-hand corner of the Program screen and select “Util” from the menu bar.
 - c. Select “Toggle Laser”. This will turn the laser pointer drive on. To turn the laser pointer off, select “Toggle Laser” again.



Note: the laser should be turned off when not in use to extend the life of the laser and to prevent accidental exposure.

3 PDA

Before you can start programming, you must first install the EFD Ultra TT PDA software Version 1.2 to your PDA.

Download the Software Installation CD that was included with the PDA to the PC. Once that is done download the EFD PDA software to the PC. Copy the EFD PDA software to the palmOne Quick Install and then HotSync to install the EFD PDA software to the palm.



Currently, only selected PDA handhelds⁶ can be used with the EFD Ultra TT programming software. However, it is intended that the software will be available for other makes of PDA's. Please check with your Ultra TT salesperson for more information.

Please refer to the Ultra TT User CD for detailed installation instructions.

The Ultra TT software is divided into three specific sections.

Setup: Setup basic system parameters such as valve selection, system-park, purge cycle and initial offsets.

Programming: Teach origins, specific points and dispensing parameters.

Tools: For troubleshooting and advanced software upgrades.

CAUTION: Changes in this area should be performed under strict supervision or by your EFD Ultra TT representative. Failure to do so may cause programs not to operate or run properly.

Next, plug the pre-configured Socket Adapter that came with your machine to the rear of the RS232 COM port of the Ultra TT System. Power up the Ultra TT and verify that the Socket adapter is blinking.

Then, turn the system on by pressing the green power button on the front panel. In the Main Menu, select *Tools* > *Bluetooth* > *Discover*. Wait about 15 seconds to list any wireless devices in range. Highlight the EFDSNxxxxx (the "xxxxx" is the 5-digit serial number of the Ultra TT unit) entry in the list, then tap "Connect".

Enter 1234 as the passkey for the Socket Adapter. Verify that the "Add to trusted devices list" option is NOT selected, then tap "OK". Your PDA is now paired with the Ultra TT unit.

⁶ The minimum Palm OS version is 4.0. The following Palm handhelds have been tested and are known to work with the EFD Ultra TT software and hardware:

With the Teach Pendant Cable (700818): Zire™ 71, Tungsten™ C, m515, m505 and the m500. The Tungsten T, T2 and T3 can be used but only with Firmware version 1.1 and above. Sony Clie® PEG-TJ37 may also be used but requires baud rate on machine to be switched (See your EFD Ultra TT Representative for further instructions).

With Bluetooth: Zire 72, Tungsten T, T3, T5 and E2.

important notes

Recharge PDA and sync it to your computer at the end of every day. Otherwise, you may lose the information entered since your last sync session.

The next time you want to connect to the Ultra TT using the same PDA, launch the EFD Ultra TT PDA application. When asked if you wish to reconnect to the last device you communicated with, select "Yes" and go through the reinitialization steps.

If you are using a new PDA or a different PDA from the one last used/paired with the Ultra TT, you must perform the discovery and pairing procedure on the new PDA with the Socket Adapter installed on the Ultra TT.

If the PDA ever gets out of range of the Ultra TT (approx. 30 ft.), Communications Error #1104 will occur. The Bluetooth connection will be reestablished automatically when the PDA comes back into range.

If the PDA powers down; it may be able to reconnect without restarting the Ultra TT and the EFD Ultra TT PDA application by waiting 8-10 seconds. In this case, the Bluetooth Reconnect window will pop-up and communication will be established. If the reconnect window does not pop-up, restart the application by returning to PDA Home and relaunching the EFD Ultra TT PDA application.

4 SYSTEM CONFIGURATION

After performing the discovery and pairing of the PDA and the Ultra TT (Section 3), go into the Setup screens to configure your Ultra TT system for the specific valve/syringe barrel setup appropriate for your fluid dispensing application. You have to complete this setup first or you will not be able to program the dispensing pattern correctly.

From the Main screen, tap "Setup". This will take you into the Setup screen. If this is the first time you are accessing the software since powering up, a message informing you that the dispenser is "about to home". Tap "OK" to continue.

There are a total seven (7) Setup screens:

1. Valves
2. Units
3. Height Sensor
4. Park Location
5. Purge Valve #1
6. Purge Toggle
7. Safe Z

Allows operator to navigate forward or backward between setup screens

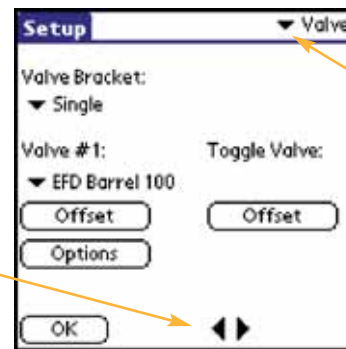

Allows operator to select a specific setup screen from a pull-down menu

4.1 VALVE SELECTION

First, make the Valve Bracket selection i.e. Single, Dual, Triple or Toggle.

When using dual or triple valves, you are required to mechanically align the secondary and tertiary valves to your parts.

4.1.1 Valve #1

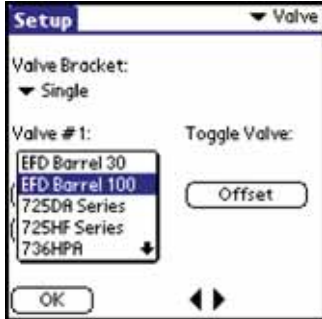

Next, select the model of Valve #1 from the drop-down menu.

This software allows for specific settings to be configured for each valve in the Valve Options screen. Make the appropriate selections for the application requirements.

Example 1: The 780S Valve Options screen allows the User Operator to specify nozzle air on/off delay.

Note: the default is a 0.24/sec nozzle air delay, but this setting is configurable from 0 to 5 seconds in 0.01 sec increments.

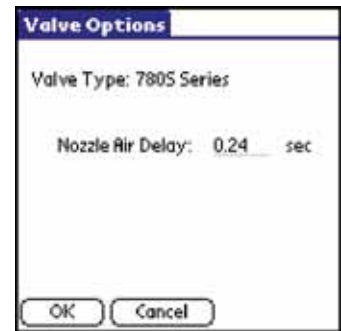

Example 2: The 790 Valve Options screen allows the Operator to select either constant or pulsed pressure from the P2 (0~30 psi) channel. There is also the additional option of having the fluid pressure turned off at the park location.

Note that when configured for Constant Pressure (P2) and Pressure Off at Program End i.e. both boxes are checked as shown in the figure on the left:

- The fluid air is turned on during purging and program run.
- Aborting the program will turn off the fluid air.

Speed control is determined by applied voltage to the motor. This speed is maintained through the use of a Back EMF circuit to ensure constant velocity. The range of operation is from 10 VDC to 24 VDC in 0.1 VDC increments.

4.1.1.1 Teaching Tip to Probe Offset

This is an optional function. You will need to teach the dispense tip to probe offset only if you intend to use height sensor commands within the program. It is recommended you use the height sensor if your application requires very small dots or fine lines. The tip to probe offset allows you to teach the height difference between the tip and the height sense probe (which is essentially also the surface of your part).

To teach the offset:

- (1) Tap "Offset" under Valve #1 label in the Valve screen.
- (2) To jog the dispense tip to the surface of the part, tap "Jog" located at the top right of the screen. The Jog window appears. Now, jog the dispense tip to a point on the surface of your part.

Refer to [Appendix A](#) on detailed jogging instructions.

- (3) When the desired location is reached, tap "OK".
- (4) Tap "Teach" corresponding to instruction 2. The machine will raise the Z-axis and advance the probe.
- (5) Tap "Jog" again and jog the height sensor probe to the same surface point. Tap "OK".
- (6) Tap "Teach" corresponding to instruction 4. Your machine now knows the XYZ offset for the current tip location.

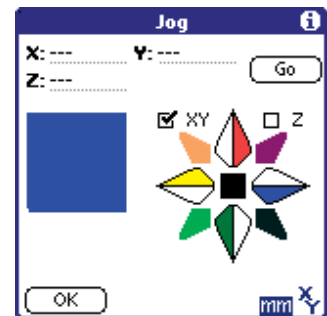

WARNING! Do not toggle the height sensor probe when the Z-axis is lowered; this could cause damage to the machine and/or the part.



Tip: The minimum tip-to-probe offset is 6mm. This is an approximation of the distance the probe must move from surface contact to tripping the sensor (i.e. surface detection) without crashing the tip.

4.1.2 Toggle Valve



If a Toggle bracket is selected, you will also need to teach an offset for the toggle valve. Follow the instructions in Section 4.1.1.1 to teach offset for the Toggle Valve. However, prior to teaching the offset, the toggle valve bit configuration must first be completed.

4.1.2.1 Configuring Toggle

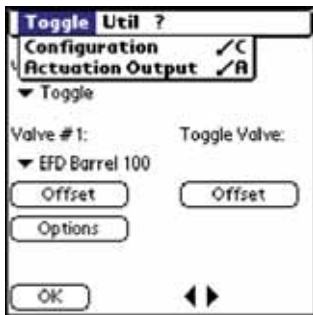

1. At the Setup screen, tap "Setup" at the upper left-hand corner of the screen.
2. Select "Configuration" to configure the toggle bit (the internal I/O instruction to turn on the solenoid for the toggle bracket).
3. Enter the desired I/O bit to turn on the air solenoid i.e. will cause the toggle bracket to shift. Select Output Bit 7 for EXT_SOLENOID_B or Output Bit 6 for EXT_SOLENOID_A.



Note: The Ultra TT provides two external outputs to drive air solenoids. Each solenoid driver has a maximum power rating of 5 Watts. Select desired assertion level. To test the toggle bit you can press the down button to assert the toggle bit and press the up button to negate the toggle bit.

The EXT_SOLENOID_A and EXT_SOLENOID_B connections are made on the Discrete I/O terminal block located on the rear panel.

- 24VDC+ is supplied on Pin 14
- EXT_SOLENOID_A is supplied on Pin 13
- EXT_SOLENOID_B is supplied on Pin 12
- GND is supplied on Pin 11

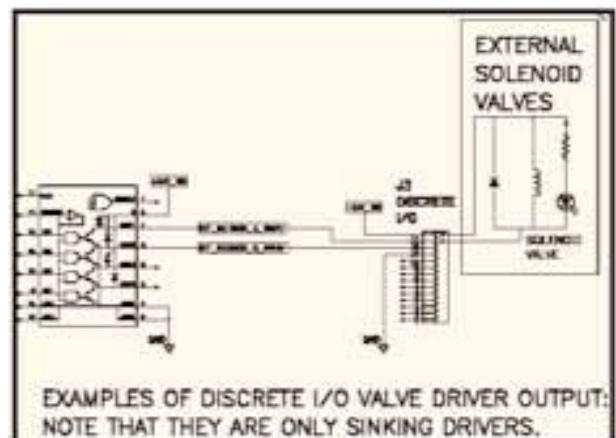

4. Select the Assertion Level, which defines whether a "1" or a "0" written to the Output Bit will cause the toggle bracket to move down.
5. Tap "Up" or "Down" to test the toggle bracket for the proper Output Bit and Assertion Level.
6. Tap "OK" to return to the Setup screen.
7. Now select "Actuation Output" from the Setup drop-down menu.
8. The Valve Actuation configuration screen allows the user to select which output will actuate the toggle, secondary or tertiary valve.
9. Tap the down arrow and select the desired discrete output from the drop-down menu. The EFD dispensing controller for the toggle valve is connected to this discrete output. The EXT_OUTPUT_A or EXT_OUTPUT_B are the preferred bits.
10. Tap "OK" to return to save the settings before returning to the Setup screen or "Cancel" to return to Setup screen without saving.

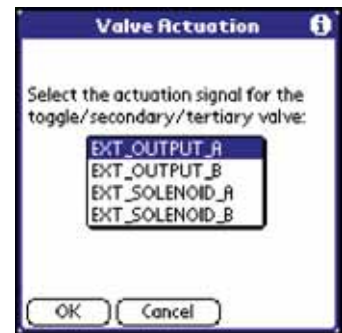

Note that the default toggle delay value is 0.5 seconds. The delay is used for both lowering the valve and for raising the valve. If you need to change this delay, please contact your EFD Ultra TT Representative.

4.2 UNITS



Select the desired units to be displayed from the drop-down menu. Options are in inches or millimeters.

4.3 HEIGHT SENSOR

Each Ultra TT system is equipped with a standard tactile height sensor. The height sensor allows the Operator to activate the dispense gap function in a dot/line parameter.



There are six (6) adjustable parameters for the height sensor:

Probe Down Delay: This is the delay, after the tactile probe is extended (with a height sense command in a program), and before the Z-head starts to move. Unit is in seconds and the default is 0.25 seconds.

Down Speed: This is the speed (in mm/sec or in/sec, depending on the Unit setting) that the Z-head moves downward within a height sense command. Default is 50.8mm/sec or 2in/sec. Down Speed has the greatest effect to height sense accuracy and should not exceed 70mm/sec or 2.75in/sec.

Note: The "Tip To Probe XYZ Offset" routine (in the Valve Setup window) should be performed anytime this down speed is changed.

Max Distance: This is the maximum length of Z-head travel for the probe to sense the surface of the part. Default is 100mm or 3.9in. A shorter distance is preferable but not mandatory. To reduce the amount of over travel in the event that the surface is not found, the "Max Distance" can be reduced from the default of full travel (100mm). However, if this value is too short and the probe does not touch the part surface after traversing this length, an error will occur.

Up Speed: Speed in which the Z-head moves upwards after a height sense. Default is 50mm/sec or 1.97in/sec.

Retract Distance: After a height sense, the Z-head moves up this retract distance before moving to the dispense location. Technically, the probe touches, the probe is lifted, wait the "Probe Up Delay" and then the Z-axis is moved up (a relative move) the "Retract Distance."

Your height sense command should be invoked at a location very close to the dispense location. For this reason, the default is set at 2.5mm or 0.1in. Amend this retract distance to a higher value if the height sense was invoked farther away from the dispense location and the dispense-tip/Z-head needs to clear some obstacles while moving to that location.

Probe Up Delay: This is designed to allow the tactile probe to retract completely before starting any XYZ movements. The units are in seconds. Default is 0.25 seconds

4.4 PARK LOCATION

The park location is the position you want the dispense tip to move to after it has completed its taught program. This location is often a position closer to the work-piece than mechanical home in order to shorten the work cycle and also allows ample space for the part to be removed from the fixture plate.



The default park location is set to mechanical home position which is X=0,Y=0, Z=0. This is indicated in the drop-down box as Home.

To teach a new park location, first select "New". Enter the new Park Location name. Next, teach the location by tapping "Jog" and moving the dispense tip to desired location. Tap "OK" to return to Park Location setup screen. Tap "Teach" to complete the new Park Location setup.

To use the toggle bracket at park location, check the "Use Toggle" box. This will actuate the toggle bracket i.e. toggle down, at that park location, otherwise, the toggle bracket will toggle up at the part location. Teach the park location as above.

Maximum number of locations is ten. Note locations include park, purge and purge toggle.

4.5 PURGE VALVE #1

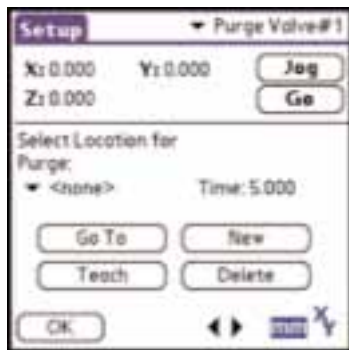

To teach a new purge location:

1. Select "New". Enter the new Purge Location name.
2. Teach the location by tapping "Jog" and moving the dispense tip to desired location. Tap "OK" to return to Purge Location setup screen.
3. Enter the desired purge time (in seconds). Note that the purge time is limited to a maximum of 65.535 seconds.
4. Tap "Teach" to complete the new Purge Location setup.
5. The selected purge routine is downloaded the next time a download from the PDA occurs. Once downloaded onto the machine, the purge routine can be accessed through the front panel LCD in program 99.

4.6 PURGE TOGGLE

This screen performs the same function as in Section 4.5, except it is for the Toggle Valve instead of Valve #1.



This purge routine can be accessed through the front panel LCD in program 98.

From time to time, you may want to run the purge routine from the PDA. This can be accomplished by selecting "Util" in the Program mode then select "Purge Main" or "Purge Toggle" from the drop-down menu

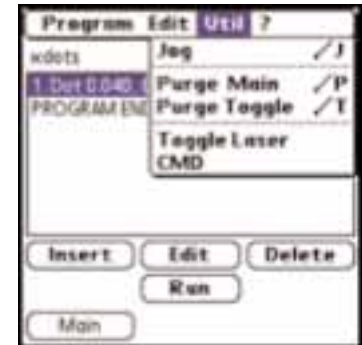

4.7 SAFE Z

This feature allows a lower "safe" Z height (reference to Z=0) to be set so as to reduce the time it would otherwise take if the Z head has to return to the "0" position before each XY movement. It is especially useful if the part is very low i.e. daylight is large.

The safe Z height is the height the Z head will move to before any XY non-dispense movements. Note that the height the Z head moves to between dispense locations within a program, is dictated by the retract distance specified for that line or dot type.

The safe Z height should be a high enough position to clear any objects in the machine's XY envelope. If the Safe Z is not configured, the machine will move the Z head up to the "0" position before any XY movements.

To set a safe Z height:

1. Select Safe Z from the top right-hand drop-down box.
2. The probe will be actuated and drop down. If a toggle bracket is used, the toggle will also be actuated.
3. Using the probe and toggle, if applicable, as reference, move the Z head to a height where both the probe and toggle clears any object in the XY envelope. The probe should not be touching anything.
4. Tap "Teach".
5. Your Safe Z height has been set



5. PROGRAMMING

5.1 CREATING A NEW PROGRAM

Before you start this exercise, print out the form called "Teaching Template" in Appendix B of this guide.



1. Install the tooling plate⁷ on the Y-carriage and attach the printed template on it with cellophane tape.
2. Tap "Program" in the Main screen. This will take you to the program edit window.
3. From the Program drop-down menu, select New. This will open a dialog box to name your new program.
4. Type in new program name. Note that program names are case-sensitive. If an attempt is made to create a new program with the same name as the program currently opened, an error message will be displayed.



5. Tap "OK". This will open the Teach Program Origin window. The program origin is the point in the program from which all other movements relate to, or the (0,0) coordinate of the program.

Refer to [Appendix C](#) for a detailed explanation of Program Origin.

6. Tap "Jog" to open the Jog window. Use the compass rose to move the dispense tip to the position marked "Origin" on the template.

Refer to [Appendix A](#) for detailed jogging instructions.

7. Tap "OK". Tap "Teach" and then "OK". This will open the program edit window.

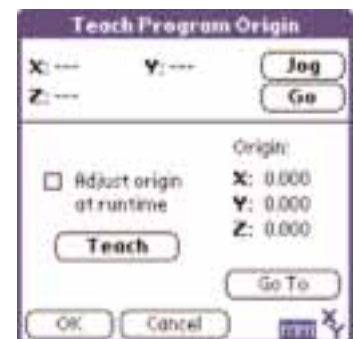

⁷ EFD can supply two tooling plates: 300 X 300mm (P/N 7007-300) or 500 X 500mm (P/N 7007-500). Alternative, user can design their own (reference System Drawings on Operation CD).



8. The Program window is where points are inserted, deleted and edited. This is the main programming window. Now you are ready to insert dispensing points into your program.

5.2 TEACHING DISPENSING POINTS

To start dispensing, dispensing points must be located and taught. Dispensing points can be located in two ways:

- Using the nozzle tip;
- Using the laser pointer.

With the first method i.e. using the nozzle tip, you can elect to invoke the height sensor or not. However, the height sensor must be used in conjunction with the laser pointer in teaching dispensing points.

To teach dispensing points with the laser pointer:

1. First, ensure that the tip to probe offset has been setup (Refer to Section 4.1.1.1).
2. Before programming, turn the laser pointer on:
 - a. Using the PDA, select "Program" from the "Main" screen.
 - b. Tap the top left-hand corner of the Program screen and select "Util" from the menu bar.
 - i. Select "Toggle Laser". This will turn the laser pointer drive on.
3. Establish the origin of the program using the laser pointer.



4. Insert a height sense instruction as close to the first dispense point as possible. You may choose to use the probe or the laser pointer to teach the height sense location. If you choose the latter, remember to check the "Teach with Laser Pointer" box.

5. Teach the dispense points using the laser pointer as you would using a nozzle tip. Use the dispense gap for each dot/line type to determine the z-height of the dispense point/line.
6. When all dispense points have been taught, return to the program origin and re-teach the origin using the nozzle tip (instead of the laser pointer as you had done in Step 2 above).

5.3 TEACHING A DOT

Next, we will program four dots and set the desired dot parameters (Figure A on the template).



1. In the Program menu, tap "Insert" to start inserting program instructions. This will open the Select Instruction window.

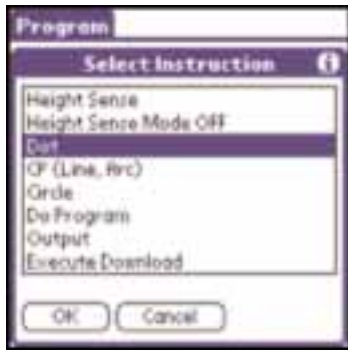

2. In the Select Instruction menu, select Dot and tap "OK".
3. You are now required to teach the first dot position. Tap "Jog" to open the Jog window. Position the dispense tip to the first point and tap "OK".

Select a number for Dot Type.
Tap "Edit" to open the Dot Parameter window.

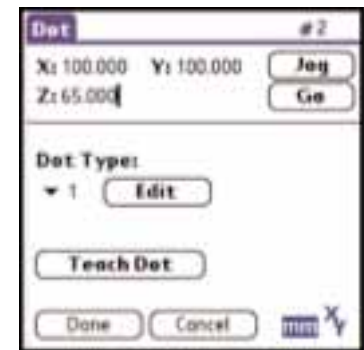

4. If the toggle bracket is selected in the Setup window, the toggle box will be visible to the Operator to select. Check the "Use Toggle" box if the dispense is to use the toggle valve/syringe-barrel. Teach the dispense location (Refer to 3 above) using the toggle valve or syringe-barrel.

Note that when the program is running, the toggle will actuate i.e. move down, before it begins to move to the taught dispensed location.



5. Enter the desired value for each Dot Parameter field. Refer to [Appendix D](#) for a detailed description of the different parameters that make up a Dot Type. When done, tap "OK".
6. Tap "Teach Dot" to insert instruction. Each time "Teach Dot" button is pressed the line number will increment (circled in the left graphics). It allows the user to (1) verify that the Teach was taken and (2) confirm which instruction is being inserted / edited.

7. Jog to the next dot location. Select a dot type, if different from the earlier selection. There can be up to ten unique dot types per program.

8. Tap "Done" once all four Dot instructions have been taught. This will take you back to the main Program window.

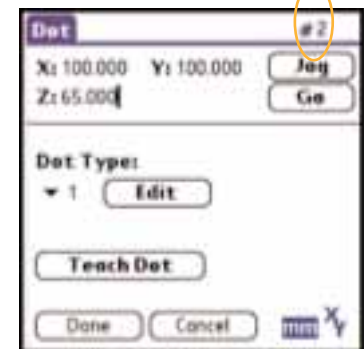

5.4 TEACHING A CONTINUOUS PATH

A Continuous Path (CP) generates a constant velocity path along which the assembly fluid is dispensed. Constant velocity is key in ensuring that the bead diameter does not vary. Note that the closed-loop encoder feedback feature in the Ultra' TT system ensures that constant velocity is maintained throughout the continuous path.

Use a CP Stop instruction when you want to eliminate the auto-blending capability associated with CP Mid instructions. This will ensure that the exact position is reached.

Continuous path has several subsets of instructions:

- CP Start Point
- CP Mid Point
- CP Arc Point
- CP Stop Point
- CP End Point

All CP paths must start with the CP Start instruction and can only end with a CP End instruction. If this syntax is not followed, then the machine will provide the operator with an error message. Prior to teaching line instruction, you must set desired line parameters.

Refer to [Appendix E](#) for detail explanations of each line parameter.

5.4.1 CP LINE

We will now program the continuous path for Figure D on the template.

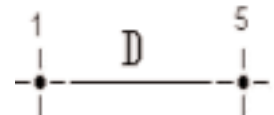

Note: "1" = CP Start; "5" = CP End.

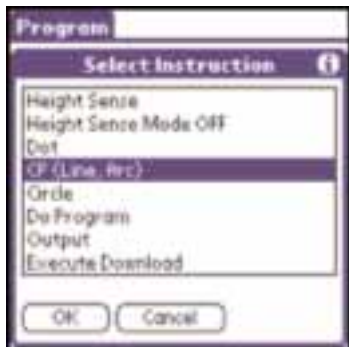

1. Tap "Insert" in the Program edit window. Select CP from the Select Instruction window. Tap "OK". This will open the Continuous Path window.
2. Tap "Jog" and jog the dispense tip to the 1st point (marked 1). Tap "OK". From the Point Type drop-down menu, select Start.
3. Select line type. Tap the "Edit" button to enter the desired values for Line Parameters.

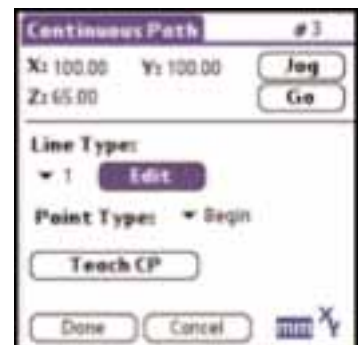

Refer to [Appendix E](#) for detailed explanation of each line parameter.

- When complete, tap "OK" to exit the Line Parameters screen.
- Tap "Teach CP" to insert this instruction in the program.

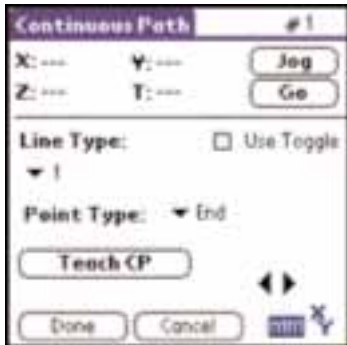

- Tap "Jog" and jog the dispense tip to the 2nd point (marked 5) of Section D. Tap "OK". Select End from the Point Type drop-down menu. Tap "Teach CP". The CP line has now been taught and inserted into the program.

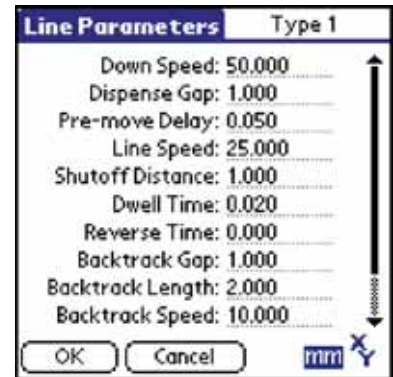

- Tap "Done" to return to the Program window.

8. If the toggle bracket is selected in Setup, then the "Use Toggle" box will appear in the Continuous Path screen. Selecting the "Use Toggle" box indicates to the Ultra TT System that it must actuate the output to move the toggle valve down prior to dispensing.



5.4.2 ARC

The arc command is strictly 2-dimensional i.e. Z values remain the same throughout every single element in the arc. The Z-value at CP Start is the value used in the (2-dimensional) arc.



ABC = Clockwise
CBA = Counterclockwise

To teach a stand-alone arc, three points are needed i.e. CP Start, CP Arc and CP End. The order in which these three points are taught will determine the direction of travel during the actual dispense. An arc point must have an anchor point before and after it and can never be followed with another arc point. An error message will appear if this syntax is not followed.

Next, teach the arc in Figure B on the template.
Note: "1" = CP Start; "2" = CP Arc; and "5" = CP End.

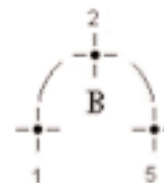

- Select "CP" from the Select Instruction window. Tap "OK". This will open the Continuous Path window.
- Tap "Jog" and jog the dispense tip to the lower left point of the arc (marked 1). Tap "OK".

3. Select CP Start from the Point Type drop-down menu and tap "Teach CP". The program will now advance to the next instruction line in the program.
4. Tap "Edit" to set the line parameters accordingly for this arc application.
5. Tap "Jog" again and move to the point at the top of the arc (marked 2). Tap "OK" and select Arc from the Point Type drop-down menu. Tap "Teach CP" to save this point.
6. Tap "Jog" a third time and jog the dispense tip to the end point (marked 5). Tap "OK" and select End from the Point Type drop-down menu. Tap "Teach CP" to complete teaching the arc.

Note that the direction of travel for the arc just taught will be clockwise.

5.4.3 CIRCLE

The circle command is strictly 2-dimensional i.e. Z values remain the same throughout every single element in the circle. The first Z-value entered is the value used in the (2-dimensional) circle.



The next exercise is programming a circle (Figure C on the template).

Note: "6" = Circle

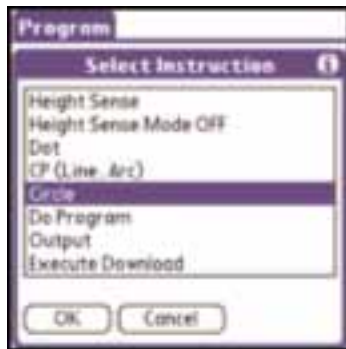

1. From the Select Instruction window, select Circle then tap "OK". This will open the Circle window and the operator is required to teach three points along the diameter of the circle.
2. Jog to the desired start point of your circle, then tap "OK". Tap "Teach" to register the first point, then jog to a second point along the diameter of your circle, tap "OK". Tap "Teach" to register the second point. Repeat this process for the third point. Once all three points are taught, the Operator needs to determine desired direction of travel for the circle pattern. Default is a counter-clockwise direction but can be changed by checking the box marked clockwise.

3. If the toggle bracket is selected in the Setup window, the toggle box will be visible to the Operator to select, if desired. The line parameters can be set or changed in the "Line Parameters" window.
4. If the three points taught do not define a circular shape, an error message will appear.

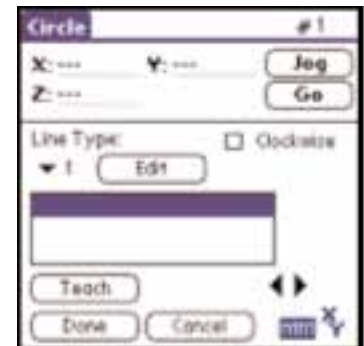

5.4.4 IRREGULAR CONTINUOUS PATH

Teaching irregular shapes requires the software to tie different elements together in a way that the taught path can be maneuvered in a smooth manner at a constant velocity. Short moves at sharp angles will limit the speed paths that can be run and should be avoided.

Note: You can only incorporate lines and arcs elements in an irregular continuous path if it is strictly 2-dimensional. Otherwise, you will need to simulate the arc as a best-fit spline using several Mid-point commands.

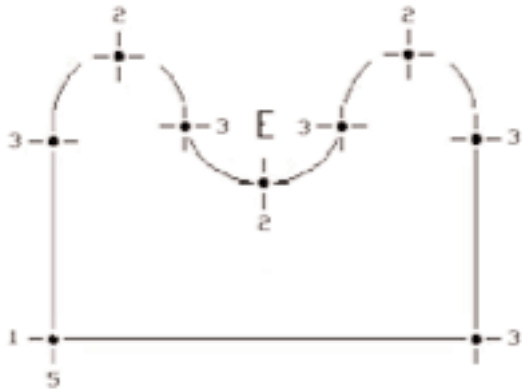

Next, program Figure E on the template.

The key at each point on Figure E indicates the Point Type required to achieve the desired path.

Note: "1" = CP Start; "2" = CP Arc; "3" = CP Mid;
"5" = CP End

1. From the Select Instruction window, select CP and tap "OK".
2. Select Point Type: Start, and tap "Jog". Move the dispense tip to the mark indicated with "1", then tap OK.
3. Select the Line Type and tap the "Teach CP" button.
4. Tap "Jog" to move the dispense tip to the next point in the path selecting the indicated Point Type.
5. Be sure to teach the path in the same direction until you are back at the starting point. Note that the CP instruction must end with a CP End command.

5.5 HEIGHT SENSE

Height sense provides the Ultra TT with the work-piece surface datum. This allows the dispense tip to accurately move to the specified dispense gap in either the dot or line parameters.

Before inserting a height sense, it is important that the height sense probe to dispense tip offset has already been taught during Setup (Refer to Section 4.1.1.1) or the Z-offset macro from the front panel be run. The Z-offset macro is located in program 97 for valve #1 and program 96 for the toggle valve.

If a height sense instruction is not inserted within a program, the dispense tip will position itself at the taught Z-height.



1. From the main Program window, locate the instruction line where you want to insert a height sense command.
2. Tap "Insert". This will open the Select Instruction window.



3. Select Height Sense, then press "OK". The Z-axis will go to Safe Z position or Z=0 (if there is no Safe Z specified), and advance the probe.



4. Jog the probe to the location desired to take the height sense. This location should be as close to the dispense location as possible. Tap "OK" and then "Teach". "Toggle" will allow the operator to manually toggle the height sense probe up and down as desired.

If teaching the height sense location with the laser pointer, ensure that the box "Teach with Laser" is checked.

5. Continue programming dots or continuous paths. Remember to assign a dispense gap for each dot/line type. New height sense instructions can be inserted anytime and will override the previous height sense.

6. Lastly, to get the machine to use taught Z coordinate for dispense height, you must turn the height sense mode off by inserting a *Height Sense Mode Off* instruction. All instructions following a *Height Sense Mode Off* instruction will use the taught Z coordinate until a new Height Sense instruction is encountered.



5.6 STEPPING AND REPEATING (REGULAR INTERVALS)

The step and repeat function is very useful when there are several similar parts on a fixture. Once a pattern or points have been taught for one part, you can now step and repeat the pattern or points for the rest.

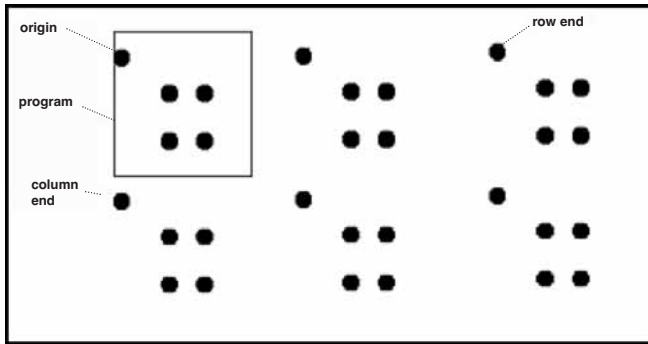

The origin is an important element in a step-and-repeat routine.

In the example to the left, the origin is used as the reference point to step and repeat the 4-dot pattern in the 3X2 matrix.

Note that in this example, the origin is displaced from the start point. This relationship must be maintained when programming Row and Column end points.

The origin can also be the first point in your program.

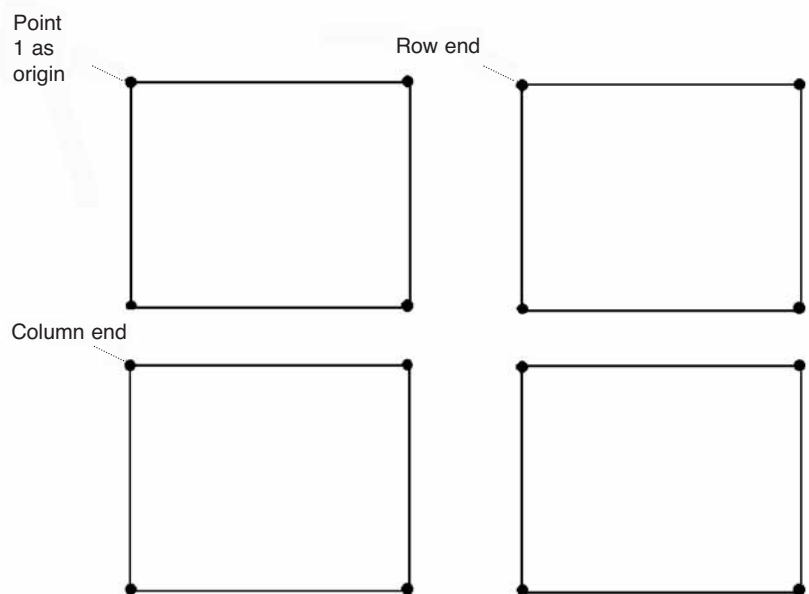

1. Tap on the Program menu bar and select Step & Repeat from the Edit drop-down menu.

- To apply Step and Repeat to the entire program, select On.
- Enter the number of rows and columns corresponding to the parts on the fixture. Select either traversing via row or column. Check the Serpentine box if desired.

Corresponding to the above 4-dots example, we have taken 4 dots and program origin and stepped and repeated them in a 2X2 matrix. For a Y serpentine, you would select step and repeat on rows = 2, columns = 2, Traverse = Column, Serpentine = *pi symbol*.



- Tap the Origin "Go To" button to check that the needle tip lines up with the origin of the program.



- Tap the Row End "Edit" button and jog tip to the origin point of the first row's end position. Tap "Teach" before tapping "OK" to return to the previous screen.
- Repeat (5) for the Column End.



5.7 INSERTING A DO PROGRAM INSTRUCTION

For some applications, it may be necessary to insert a program into another. An example: if there already exists a program to dispense solder paste pattern for 1.25mm BGA, this program could be inserted at specific point on a new program being created for a circuit board. It is important to note that the dot and line parameters of the original program become null and void. The Operator must set new parameters in the higher level/current program.



- From the main Program screen, tap "Insert" to open the Select Instruction screen.

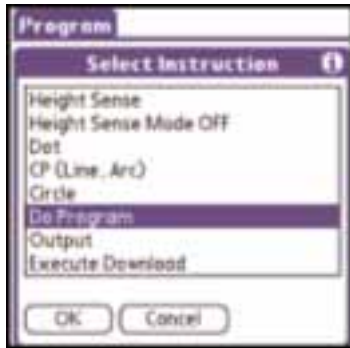

2. Select Do Program and then tap "OK" to open the Do Program screen.
3. Select the name of program to insert from the Program drop-down menu.

4. Default for the "Do Program" instruction is at a specific XY location. Hence, the check box "Use XY" is selected by default. If the program is to be placed at a Z location as well as an XY location, check the "Use XYZ" box.



5. Tap "Jog" and jog the dispense tip to the desired insertion point. Tap "OK" and then "Teach". This inserts the program at that point.

Note: The origin of the program called out is inserted at the location (either XY or XYZ) you just taught.



6. From the Edit window, select Dot or Line Parameters and enter desired values. The higher-level program ignores the dot line parameters of the lower-level programs. If these values are not adjusted in the higher-level program, all dot and line parameters will run at the default settings.

5.8 INSERTING AN OUTPUT INSTRUCTION

The Output instruction is available in the Select Instruction drop-down menu. It allows the User to insert an instruction into the dispense program that will assert or negate up to three specified output bits.

The map below indicates the pin assignment for the DB25 connector for general-purpose outputs. It also indicates the specific bit assigned to each of the output that is used in the PDA software to read output.

Pin#	Description	Name	Bit ⁸
25	spare		
24	spare		
23	D_COM_Sink		
22	D4_Sink	GP_OUTPUT_15	Bit 25
21	D3_Sink	GP_OUTPUT_14	Bit 24
20	D2_Sink	GP_OUTPUT_13	Bit 23
19	D1_Sink	GP_OUTPUT_12	Bit 22
18	C_COM_Sink		
17	C4_Sink	GP_OUTPUT_11	Bit 21
16	C3_Sink	GP_OUTPUT_10	Bit 20
15	C2_Sink	GP_OUTPUT_9	Bit 19
14	C1_Sink	GP_OUTPUT_8	Bit 18
13	Spare		
12	Spare		
11	Spare		
10	B4_Source	GP_OUTPUT_7	Bit 17
9	B3_Source	GP_OUTPUT_6	Bit 16
8	B2_Source	GP_OUTPUT_5	Bit 15
7	B1_Source	GP_OUTPUT_4	Bit 14
6	B_COM_Source		
5	A4_Source	GP_OUTPUT_3	Bit 13
4	B4_Source	GP_OUTPUT_2	Bit 12
3	A2_Source	GP_OUTPUT_1	Bit 11
2	A1_Source	GP_OUTPUT_0	Bit 10
1	A_COM_Source		

General Purpose Output Connector Map

For assistance in creating the logic scripts and to load inputs, please contact your local EFD representative.

⁸ The assigned address for the particular I/O.

5.9 EXECUTING A DOWNLOAD

Special requirements not currently available in the Ultra TT Palm software may be accommodated with downloadable ACL sequences. ACL sequences contain multiple ACL commands are downloaded onto the machine into a particular Download ID (700 – 899) and called out in a program. Please contact your local Ultra TT representative if you have such special requirement and they will advise you if your request can be accommodated.

Once your ACL sequences have been downloaded onto the Ultra TT machine, you can simply use the PDA Software program to call out the download.

- In a program, insert an instruction by tapping “Insert” button.
- Select “Execute Download” instruction.
- Type in the “Download Number” of the ACL sequence you want to call. This Download Number is indicated in the first line of the ACL sequence.

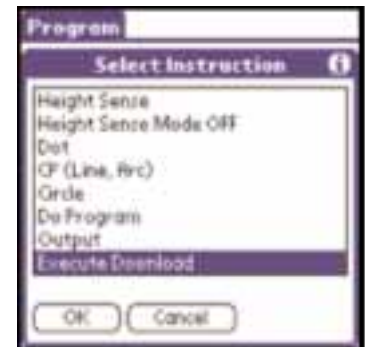

- Check the box “Move to Dispenser Location” and move the dispenser to the location you want to execute this ACL sequence.

Note: If a location is not taught in the Execute Download instruction, yet the “Move to Dispenser Location” is checked, an error will occur at runtime.

- Tap “Teach” to confirm the location.
- Tap “Done” when complete.

6 OPERATIONAL FEATURES

6.1 DOWNLOADING A PROGRAM

Once the program has been taught, it must be downloaded to the machine before it can be run. There are two ways to download a program.

- A. At the Program screen, select Download from the Program drop-down menu. This will download the current program into the machine memory without running and may take several seconds.
- B. From the main Program screen, tap "Run". In the Run window, tap "Run". The program will be automatically downloaded before it runs.

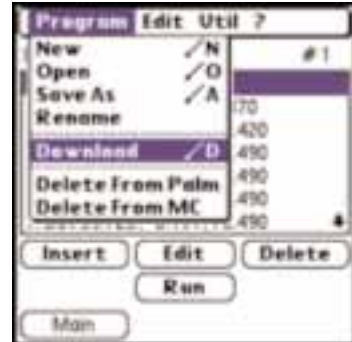

Once the program has been downloaded to the System, it can be selected from the front panel as described in Section 7 (Interactive LCD Panel) of this guide.

6.2 RUNNING A PROGRAM



Once a program has been downloaded to the Ultra TT System, it can now be run with or without the Palm handheld attached to the System.

- A. With the Palm handheld:

To run the machine with the Palm handheld attached, tap "Run" in the Program screen. This will bring you to the Run window. Tap the "Run" button. This will cycle through the taught program.

- B. From the front panel:

After loading the program into the Ultra TT System, press the soft key corresponding to RUN on the LCD.

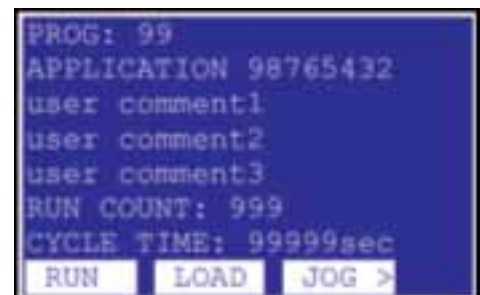

6.3 DELETING A PROGRAM

To delete a program, select Delete From Palm or Delete From MC from the drop-down menu in the Program screen.

A. To delete from PDA:

A list of all programs will appear. Select the program to be deleted and a Delete File verification window will appear. Tap "OK" to confirm the deletion or "Cancel" to escape.



B. To delete from machine:

When "Delete from MC" is selected, the user will be asked to download the program number to be deleted. Hence, the user should first browse the downloaded programs from the front panel to determine the download number to be deleted.

6.4 RENAMING A PROGRAM

To rename a program, open that program then select Rename from the Program menu.

Select Rename from the drop-down menu in the Program screen. A Rename File window will appear to allow you to edit the program name of the current program. Enter the new program name and tap "OK". The next time you download the program, the LCD will display the new name.

Once the program has been copied (save as), you will be in the new program that you just saved.

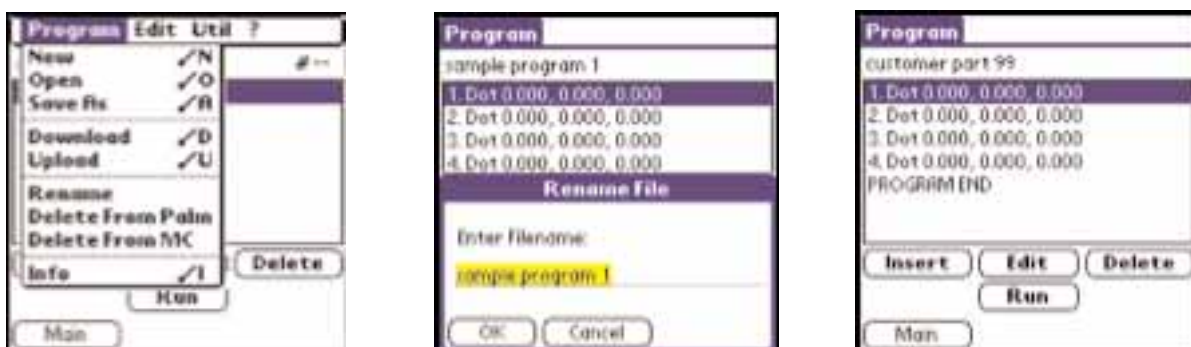

6.5 COPYING A PROGRAM (SAVE AS)

To copy an existing program, simply save the current program under a new name. This creates an exact copy with a different name.

Tap on "Save As" from the Program drop-down menu. The name of the program currently opened will be displayed and highlighted in the "Save As" edit field. This facilitates name changing when the new name will be similar to the existing program. Note that program names are case-sensitive.

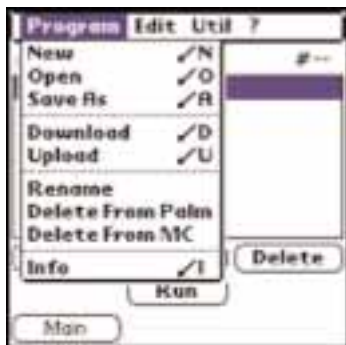

Once the program has been copied (save as), you will be in the new program that you just saved.

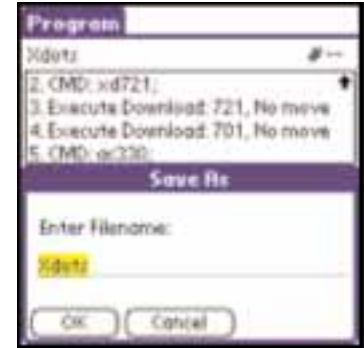

6.6 INSERTING/DELETING POINTS IN A PROGRAM

Points are inserted at the current point where the instruction is inserted. This means if you have point #5 highlighted in the Program edit window and select "Insert", you will insert a new command at that point. The current point #5 will become point #6.

To delete a point in a program, you must highlight the point and tap "Delete". This will delete the current point and move all subsequent points up by one position.

It is important to note that when editing CP points, the line type "Edit" button can only be viewed from the CP Start point. To edit the line parameter for a continuous path, you must go to the CP Start Point and tap "Edit".

6.7 CHANGING PROGRAM ID NUMBER



From time to time, you may need to reassign a program ID number. To do this, select Program ID in Edit drop-down menu. This will open the Change Program ID window.

The Change Program ID window displays the current program ID number and the closest open available ID number. You can enter the desired ID number or use the default number provided.

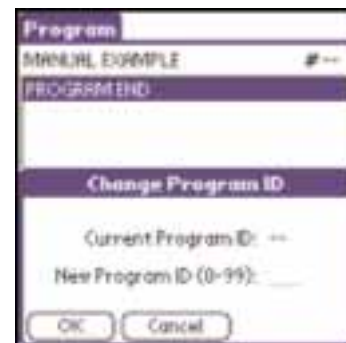

6.8 CHANGING PROGRAM ORIGIN

You can change the program origin anytime:

- Tap the top left-hand corner of the Program screen.
- From the "Edit" drop-down menu, select "Program Origin".
- Tap "Go To" to check the position of the current program origin
- Jog to the new program origin position
- Tap "Teach" to confirm

Note: Before confirming/changing program origin, the toggle valve will toggle up if it is in the down position.



WARNING! Do not tap "Teach" when Z is at zero position. Tapping "Teach" at zero position will erase all Z coordinates in the program and they cannot be recovered. You will then have to manually re-enter each line of the program.

6.9 EDITING FUNCTIONS

There are several editing functions available within the Program mode.

6.9.1 DELETING INSTRUCTION LINE(S) WITHIN A PROGRAM

1. Tap the top left-hand corner of the Program screen.
2. From the "Edit" drop-down menu, select "Mark".
3. Select the program lines you want to delete. A "->" sign will appear before the instruction to indicate which line has been selected.
4. From the "Edit" drop-down menu, select "Cut". The selected instruction lines will be deleted from the program.



6.9.2 COPYING INSTRUCTION LINE(S) INTO ANOTHER PROGRAM



- Tap the top left-hand corner of the Program screen.
- From the "Edit" drop-down menu, select "Mark" for line-by-line selections or "Select All" to pick all the instruction lines. Tap the selected line again to deselect it.
- Select the program lines you want to copy. A "->" sign will appear before the instruction to indicate which line has been selected.
- From the "Edit" drop-down menu, select "Copy".
- Go to the program you want to paste these instruction lines onto.
- From the "Edit" drop-down menu, select "Paste". The selected instruction lines will be copied into the new program.

7.1 POWER UP

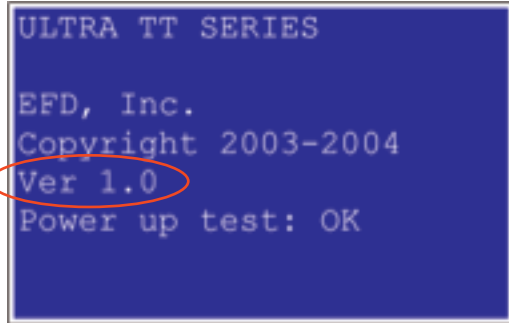

Upon power up, the LCD will display a splash screen that indicates machines version of firmware (circled). The main board power-up test result will also be displayed here (either "OK" or "FAIL").

Note: As of the published date of this manual, the most current Firmware is Version 1.1

If a power-up failure occurs, a soft key will appear to prompt for corrective actions. Press the dome switch under "Next" and follow the instructions. This will usually be followed with an error message stating what failure occurred.

Corrective action should be taken according to displayed text.

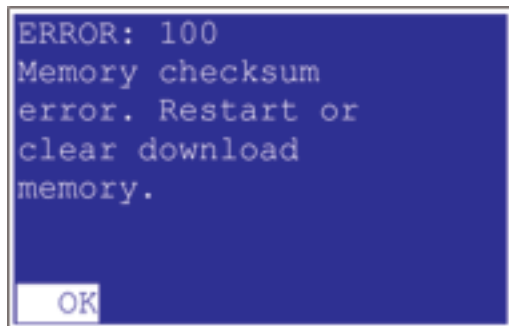

Error messages display the problem and corrective actions are to be taken. The LCD will prompt the Operator to perform a specific corrective action or refer the Operator to the technical manual for further explanations.

7.2 LOADING A PROGRAM

After the power-up sequence, the LCD will display the RUN screen of the program last executed.

To load a new program, press "LOAD". This will open the program LOAD screen.

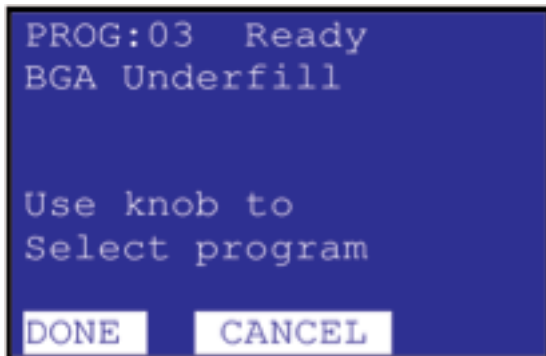
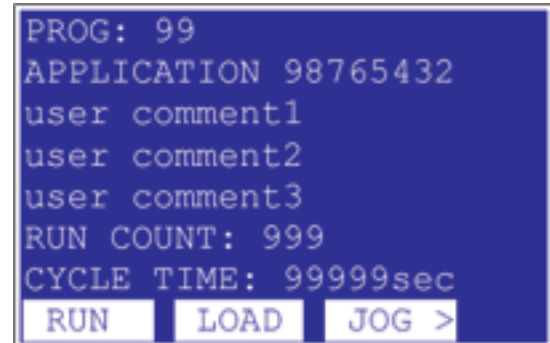

Scroll through the program list until the desired program is displayed and press "DONE".

Scrolling is accomplished with the rotary knob located on the front panel. Only previously downloaded programs will be displayed, i.e. if only four programs are downloaded onto the system, then only four programs will be displayed and scrollable in the list.

7.3 RUNNING A PROGRAM

Once a program has been selected and loaded, the LCD will display the RUN screen for that program. The RUN screen displays:

- Program Number
- Program Name
- (3) User defined comments⁹
- Run count, and
- The cycle time it took to complete the last run of the program.

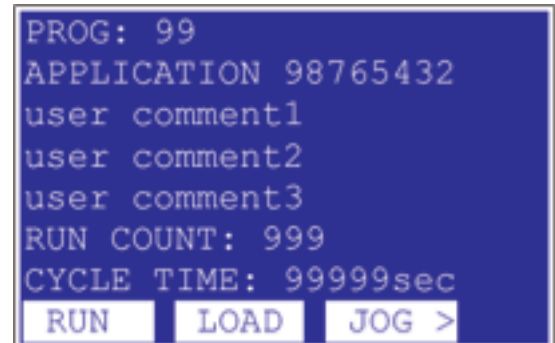

To run a program, press the button located beneath word "RUN".

⁹ The first three lines of the program are reserved for user comments. At this time, these comment lines are not accessible to the user.

To pause or abort a program while it is running, press the button beneath the respective word.



During a pause or abort command, the machine will complete its current dispensing instruction before turning the dispenser off. An aborted program ends the cycle and sends the machine to the park location.

To resume a paused program, press the button beneath the word "RESUME". This will re-start the program at the point in the program after the Pause signal was received.

Note: Aborted programs cannot be resumed.

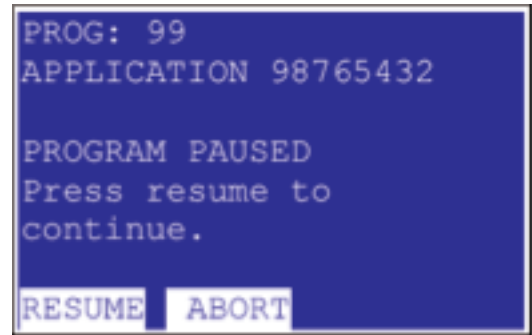

7.4 TIP OFFSET/RELOCATE

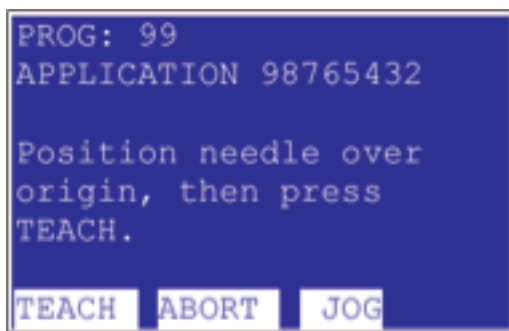

The Ultra TT System manages tip offset by adjusting the position of the program origin. The offset manager can be set to run automatically every time a program is cycled or the User can use the PDA to change origin when desired.

If selected to teach at run-time from the program origin teach window, the User will be required to verify the dispense tip location and re-teach the origin if necessary.

To relocate the tip, press the "JOG" button and then use the arrow keys on the front panel to adjust tip to the desired position before pressing the "TEACH" button.

7.5 HEIGHT SENSOR Z-OFFSET

Z Offset for the height sensor can be taught from the front panel by selecting and running, program 97 for Valve #1 and program 96 for Valve #2. Follow the four steps in the macro to accomplish the offsets. If you have inserted a height sense in your program, you must run this macro each time you change your dispense tip.

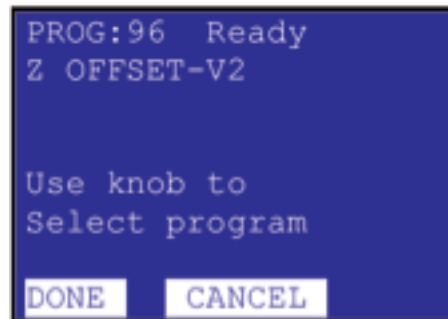
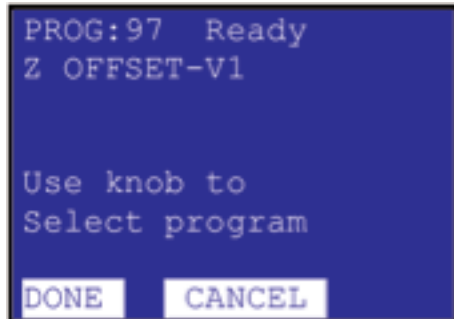

7.6 VALVE PURGE

From time to time, it may be necessary to purge the valve or prime the dispense tip. To run the purge routine, select and run program 99 from the front panel for Valve #1 and program 98 to purge the Valve #2 (Toggle Valve).

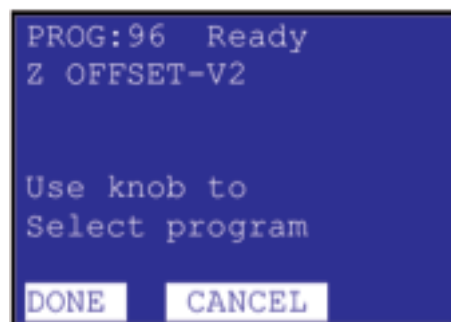
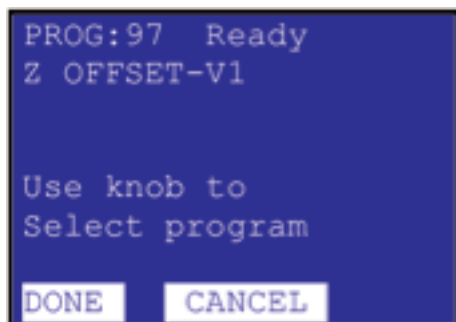

8 ACCESSORIES

Part Number	Description	Comments
1117HTT	Barrel Pressure Regulator Kit	
2000F755TT	Five micron Filter Regulator	
2000F756TT	Five micron Filter Regulator with coalescing filter	
756FLT	Coalescing Filter Assembly	
7007-300	Universal Fixture Plate, 300 mm x 300 mm	For use with the Ultra TT 325TT. Includes 4 x 700703 (edge locators) and 1 set of 700806 (fixture plate standoffs).
7007-500	Universal Fixture Plate, 500 mm x 500 mm	For use with the Ultra TT 525TT. Includes 4 x 700703 (edge locators) and 1 set of 700806 (fixture plate standoffs).
700703	Edge Locator	Four included with each EFD Universal Fixture Plate.
700801	TT Fixture Locator	To ensure valve/barrel mounting fixture is mounted at the same spot all the time. Note that this is included in each Mounting Fixture (700802-700814).
700802	TT Mounting Fixture – 750 Series	
700803	TT Mounting Fixture – 740/780 Series	
700804	TT Mounting Fixture – 725 Series	
700805	TT Mounting Fixture – 725HF/736 Series	
700806	TT Mounting Fixture – 790 Series	
700807	TT Mounting Fixture – HP7x	
700808	TT Mounting Fixture – HP4x	
700809	TT Mounting Fixture – 5800MP (Mikros)	
700810	TT Mounting Fixture – Cartridge	
700811	TT Mounting Fixture – 1/10G Cartridge	
700812	TT Angled Fixture Mount	
700814	TT Universal Barrel Mount	For use with EFD syringe barrels of all sizes
700815	TT Regulator Mounting Bracket	Attaches a regulator onto the system's T-slots
700817-T3	Teach Pendant, Tungsten T3	Use as Teach Pendant
700818	Teach Pendant Cable	Connects PDA handheld to the Ultra TT System
700819	Fixture Plate Standoffs, Set of 4	Vertical props for the
700840	Two-barrel Mounting Kit	
700841	Three-barrel Mounting Kit	
700842	Two-valve Mounting Kit	For 740, 750 and 780 Series valves only
700843	Three-valve Mounting Kit	For 740, 750 and 780 Series valve only.
700844	Dual-auger Valve Mounting Kit	For mounting two 790 Series Auger valves
700845	Triple-auger Valve Mounting Kit	For mounting three 790 Series Auger valves
700846	TT Mounting Fixture - 2800	

9 I/O

The Ultra TT has 16 general-purpose inputs and 16 general-purpose outputs. The discrete I/O's available include: 1 analog input/output, 2 digital inputs / 2 digital outputs and 2 solenoid drivers.

The Output instruction is available in the Select Instruction drop-down menu. It will allow the User to insert an instruction into the dispense program that will assert or negate up to three specified output bits. Please contact your local EFD Representative for instructions manuals if you would like to create the logic scripts and to load inputs in your application.

10 MAINTENANCE

10.1 CLEANING

Use a soft lint-free cloth to wipe the exterior of the Ultra TT machine. A commercial stainless steel cleaner e.g. Rubbermaid Professional Plus Stainless Steel Cleaner, may be used on the stainless portions of the machine. Be sure to wipe down the cleaner completely.

10.2 PREVENTIVE MAINTENANCE

Annual preventive maintenance is recommended as follows. Prior to performing any maintenance procedure, the machine should be unplugged and the power cord made visible to the User performing the maintenance. Be sure to read all MSDS sheets prior to handling the lubricants and take all required safety precautions.

The following items and instructions are included in PN7001PM-KIT are required to perform the preventive maintenance.

- Safety glasses
- Soft lint-free clothe
- 1.5mm hex wrench
- Linear bearing grease
- Rubber gloves
- Phillips screw driver
- 3.0mm hex wrench
- Cable grease

A. Lubrication of Guide Rails

- i. Remove X & Y axis covers.
- ii. Use a lint-free cloth to wipe down LM Guide Rails.
- iii. Apply a light coat of grease (NSK Brand Multi temp PS2) to guide rails.
- iv. Manually move each axis back and forth the entire length of the rail four (4) times.
- v. Wipe away any excess grease.

B. Lubrication of Cable

- i. Use a lint-free cloth to wipe down cables and pulleys.
- ii. Move the axis to home position i.e. X-axis to left most position and Y-axis to the rear of the machine.
- iii. Apply a light coat of grease (Molygraph #40-0037) to cables and pulleys.
- iv. Move the axes to maximum travel limit i.e. X-axis to rightmost position and Y-axis to front of the machine.
- v. Repeat Step (iii).
- vi. Move each axis back and forth for the entire length of the rail four (4) times.
- vii. Wipe away any excess grease.

C. Tensioning of Cable

- i. After lubricating the cables, it is a good idea to re-tension the cables.
- ii. Locate the tension block.
- iii. Loosen the two screws to the tension block.
- iv. Move the axis back and forth for two (2) complete cycles.
- v. Move the carriage back to approximately the center of the axes.
- vi. Tighten the tension block, with the carriage at mid-travel.
- vii. Replace covers.

10.3 SPARE PARTS LIST

The items below are the recommended spare parts for the Ultra TT System. Items marked * are only relevant for those customers using laser or I/O's respectively.

Part Number	Description	Quantity Recommended	Comments
7001PM-KIT	TT Grease Maintenance Kit	1	
700847	Switch, Start, Round	1	
700848	Switch, E-Stop	1	
700822	PWA Servo Amp	1	
700820-3*	Laser Module 5V	1	optional
700824	PWA Front Panel	1	
700825	Battery, nonvolatile	1	
700826	Sensor Optointerrupter	1	
2002F	Regulator, 30 psi	1	
2001C	Gauge, 0-100 psi	1	
700827	Assembly, Height Sensor	1	
700828	Plug-M 14S Screw Phoenix 3.81 mm	1	
700829	Plug-M 7S Screw Phoenix 5.08 mm	1	
700830	Plug-M 4X Screw Phoenix 5.08 mm	1	
700831*	Cable, GP Outputs	1	optional
700832*	Cable, GP Inputs	1	optional
700833*	Cable, Interlock Extender	1	optional
700834	Interlock Faker	1	
700818	Cable, PDA RS232 & Power	1	
700835	PWA programmed, main	1	
700836	Motor Assembly, DC 190 oz-in	1	
2001A	Gauge, EFD 0-30 psi	1	
2002	Regulator, 100 psi	1	
700837	Probe, 1.9 x 250 HS	1	
700838	Power Supply 320W, 48VDC, UNIV	1	
700839	Power Supply 100W, 24VDC, UNIV	1	

10.4 DISPOSAL



This equipment is regulated by the European Union under WEEE Directive (2002/96/EC). See www.nordson.com for information about how to properly dispose of this equipment.

All other customers:

Please contact EFD Customer Service at 800-556-3484 or info@efd-inc.com for a RMA number before shipping the unit back to EFD for safe disposal.

11 TROUBLESHOOTING

This section lists solutions to some possible difficulties an operator may encounter with the Ultra TT System. If you encounter difficulties not listed in this section, or if the suggested solution does not correct the problem, please contact your local EFD Ultra TT Representative. Alternatively, complete our online Technical Request Form (www.efd-inc.com/xyz/technical-form.html) and our Technical Support team will get in touch with you shortly.



WARNING! Allow only qualified personnel to perform the following tasks. Observe and follow the safety instructions in this document all other related documentation. Failure to do so may cause serious injury to the user or

Table 11.1: System Power Troubleshooting

Symptom	Possible Cause	Recovery Procedures
No power to major system components	1. The Power button has not been pressed.	Press the green Power button on the Control Panel.
	2. Main Power Cable is disconnected.	Check that the Main Power Cable is connected to an AC source.
	3. Main Power Circuit Breaker is OFF.	Turn ON the Main Power Switch at the rear of the system.
	4. The EMO button has been activated.	Turn the EMO button clockwise until it pops out. Press the green Power button on the Control Panel.

Table 11.2: Pneumatic Troubleshooting

Symptom	Possible Cause	Recovery Procedures
No air pressure	1. System is not connected to facility air supply.	Check the Main Air Inlet at the rear of the system.
	2. Main Air Regulator is OFF.	Verify Main Air Regulator is set properly.
	3. Unit has homed at start-up.	"Home" the machine to energize Main Air Solenoid. If PDA is attached, exit the EFD software program. The machine will home when you enter the EFD software program again. Alternatively, home the machine from the front panel by pressing the soft key corresponding to Jog, then press Home.
Unstable air pressure	Factory air supply fluctuates air compressor ON/OFF.	Install EFD #2000F755TT Filter Regulator and set pressure to 70 psi.
No fluid pressure	There is no air pressure.	Make sure the Fluid Pressure Regulator is set to the proper air pressure.
No valve or syringe barrel pressure	1. Main Air Switch OFF.	Make sure Main Air Switch is ON.
	2. Air pressure	Make sure the Fluid Pressure Regulator is set to the proper air pressure.
	3. Syringe Barrel Adapter is disconnected.	Check the connection at the top of the Z-head to make sure that it is installed properly and at the correct location.
	4. Incorrect setup in PDA software.	Check valve setup to ensure that the correct valve and options are selected.
Leaky Regulator	Damaged Regulator.	Contact your EFD Ultra TT representative for a replacement.
Air Regulator is hissing	This is a normal function of the 30 psi bleed-type regulator (P2). P1 is a non-bleed regulator and should not hiss.	Replace P1 if hissing.

Table 11.3: Height Sensor Troubleshooting

Symptom	Possible Cause	Recovery Procedures
Probe does not drop or retract	1. Probe malfunction.	Check for bent probe.
	2. No air pressure.	Verify Main Air Pressure is ON and set to 70 psi.
Needle hits Substrate	Probe tip is lower than needle tip when valve is in dispensing position.	Perform Tip-to-Valve-Offset. Refer to section 4.1.1.
Dispenses at wrong Z-axis position	1. Height Sensor has been adjusted, loose or binding in the drive system.	Perform a Tip-to-Probe Offset. Refer to section 4.1.1.
	2. Nozzle/needle has been changed without resetting Tip-to-Probe Offset	
PDA indicates an error message (ERR 65 – Height Sensor has detected surface before starting)	1. Height Sensor was tripped before Z-axis started the height sense move. Either the probe is still retracted, stuck in the up position or adjusted incorrectly.	Correct the Height Sensor alignment and rerun.
	2. Low air pressure.	Verify Main Main Air Pressure is ON and set to 70 psi.
	3. Electrical wires are not plugged in properly at the Z-head.	Check the connection at the top of the Z-head.
Probe hits Substrate when setting Tip-to-Probe Offset	1. Safe Z may be set too low.	Raise Safe Z.
	2. Probe is not hitting sensor.	Check to make sure that the probe is not too far below tip when extended (minimum distance below tip is 6 mm).

To Replace Height Sensor Probe

To remove the sensor you will need to remove the Z plate. To do this, pull it down by hand to access the Z balance spring or springs. Tie a wire to the spring then unhook it. Remove the four bolts from the Z head. You can now place it in top of the X beam to work on the probe. You should be able to straighten it without removing it. If you have to remove it, take the two Phillips screws out from the front of the Z plate. Remember where the little spring goes. When reassembling, be careful when you tighten the probe screw. Too tight and you can bend the probe. Reassemble in reverse order.

Table 11.4: Motion Control Troubleshooting

Symptom	Possible Cause	Recovery Procedures
No XYZ-axis Dispensing Head motion	1. No system power.	See System Power recovery procedures (table 11.1).
	2. Servo Amps failed.	Contact a service technician.
	3. +48V power supply down.	
Dispense syringe barrel or valve fails to find Home.	1. Home flag not positioned properly.	Contact a service technician.
	2. Obstruction preventing machine motion.	Remove obstruction.
Dispense syringe barrel or valve starts to move, then stop and goes Open Loop	1. Fatal following error due to excessive tooling weight or binding in drive systems.	Contact a service technician.
	2. Servo Amps failed.	
Jerky movements	1. Mechanical interference along X, Y or Z axis.	Visually inspect the axis for anything that may be restricting movement.
	2. Excessive tool weight.	Check that tool payload does not exceed 5 kg.

If the above troubleshooting guide does not resolve your problems, please fill out a Technical Request Form (Refer to Appendix F) before contacting your local Ultra TT representative.

APPENDIX A

Jogging your Machine



The machine is shipped with factory defaults that allow the machine to be jogged at easily controllable speeds. You can change the speeds by amending the values in the Preference setting within the PDA. Note that the jog settings will remain with that PDA even when connected to various machines. You can also choose to send the customized preferences to the machine.

To customize the jog preference, tap the upper left hand corner of the blue menu bar and select "Options" "Preferences".



The factory set defaults will appear. To change the settings, tap the field you want to change and enter the new value. Tap the "OK" button to save your new settings. To change the machine's jog preference, tap the "Send" button. This will cause the front panel jog to mimic the preference stored in the PDA. To change the jog preference back to factory defaults, tap the Reset button.

You have several ways to move the dispense tip, i.e. typing in the XYZ coordinates, using the blue field and compass rose or using the hard buttons on the Palm' handheld.

A.1 USING THE BLUE FIELD AND COMPASS ROSE

The blue field in the Jog window represents the work envelope. By tapping in the blue field, you can produce gross XY movements at the zero or safe Z-height. The location can then be further refined using the compass rose.

Holding or tapping a select arrow on the compass rose will move the dispense tip in that direction. Select between the two modes (XY or Z) by checking the appropriate box. The XY mode allows you to jog 8 directions, XY and 45° diagonals, while the Z mode allows for the Z-axis movement.

Two modes of jogging (XY or Z).
Check box for the appropriate mode

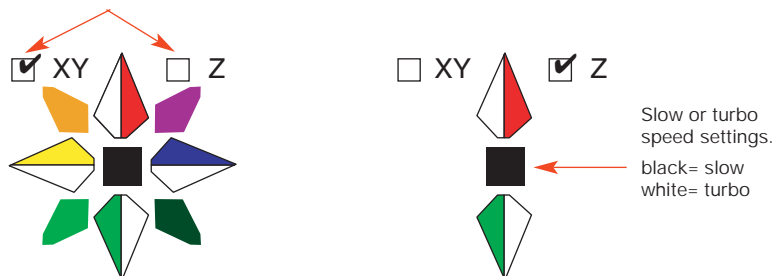

A.2 Using the Keys on the Palm handheld

In addition to the two methods stated above in the jog window, place the Palm handheld in a hard-key sensing mode to read input from the six hard keys on the Palm'. These keys move the machine in only XY or Z. Diagonal jogging is not allowed in this mode.

Note that jogging with the hard buttons is always available when the Palm' handheld is attached to the machine. So, when inserting or editing instructions the user can just jog using the hard buttons without the need to open the Jog window.

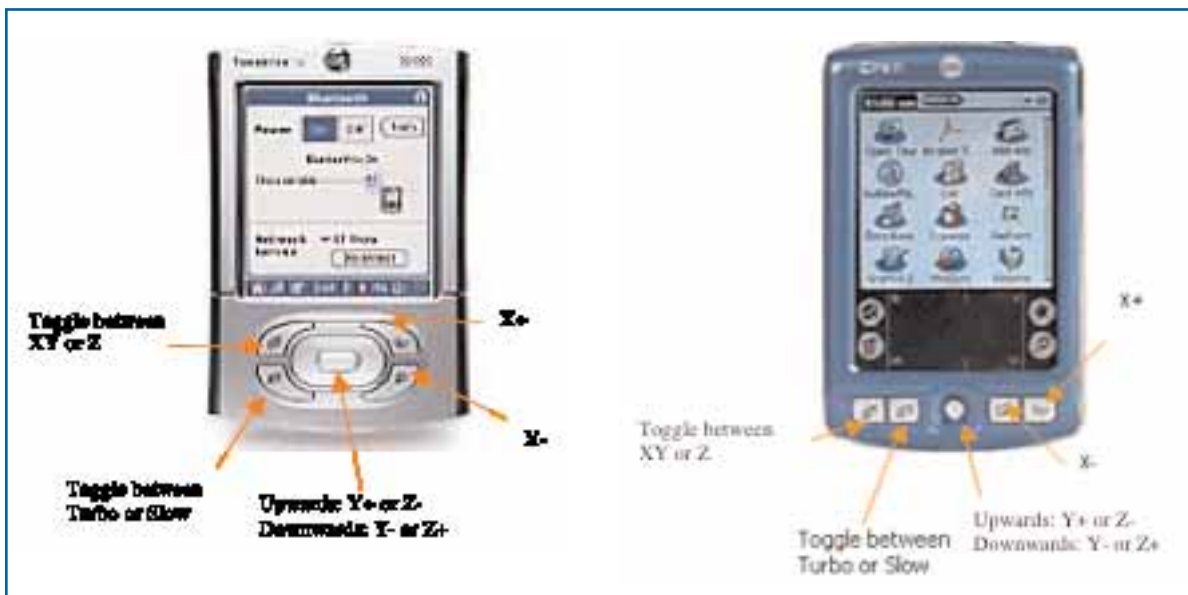

Hard keys on the Palm
Tungsten T3 PDA

Hard keys on the
Palm Zire 71

APPENDIX B

Teaching Template

Origin

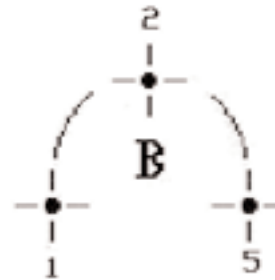
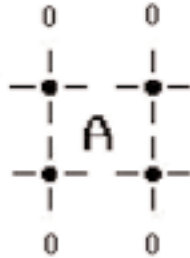

Key:

- 0 = Dot
- 1 = CP Start
- 2 = CP Arc
- 3 = CP Mid
- 4 = CP Stop
- 5 = CP End
- 6 = Circle Instruction

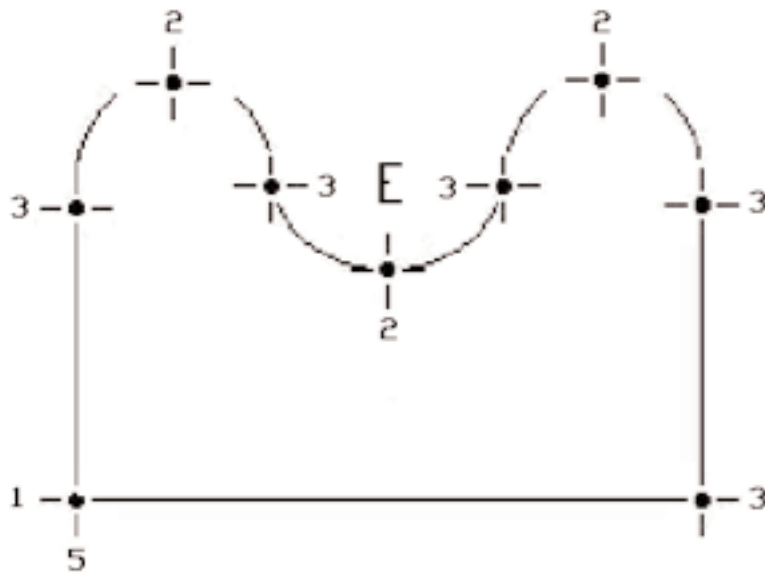
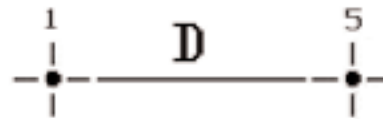
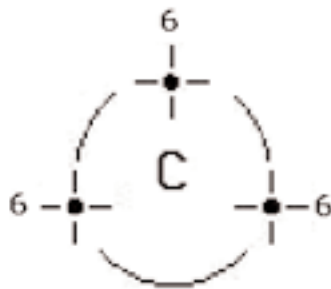

APPENDIX C

Program Origin

Program origin is the (0,0) coordinate for the program. All points in the program are relative to this location.

- i. Origin is the physical position that all moves are based upon.
- ii. The origin is used to allow for negative X/Y moves for needle offsets.
- iii. If home position is taught as origin, then negative moves cannot be accommodated for dispensing tip offsets.
- iv. The origin for a particular part can be either a specified fiducial on a part or a reference point on your work-holding fixture.
- v. The origin is often taught at the first point in a program

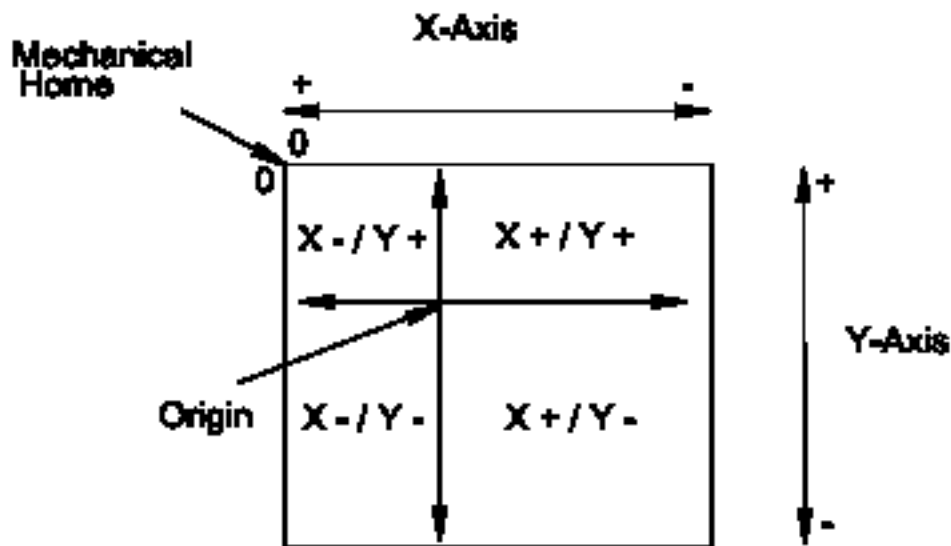

The program origin is the primary reference for all other points in a program. If the origin point is moved, then all other points will move along with it. This is how dispensing tip offsets are managed. The system can be programmed to adjust origin (offset tip location) at run time. This will require the operator to validate or teach the tip location every time the machine is cycled.

In order to create global Z adjustments, it is important to note that all Z- coordinates are displayed in absolute numbers.

APPENDIX D

Dot Parameters Explained

Dot parameters control the different aspects of a dot dispense command. They need to be set prior to running a program. Although the program already has default settings, it is highly recommended that the User Operator review and set each Line Parameter to obtain the desired application results.

Note: All time-related dot parameters are limited to a maximum of 65.535 seconds.

Down Speed

The Down Speed is how fast the dispensing head lowers to dispense. The higher the value, the faster the dispensing head will move. The units are mm or inches/second. Typically, 2 in/sec or 50.8mm/sec is the default setting.

Note that height sense accuracy is dependent on Down Speed.

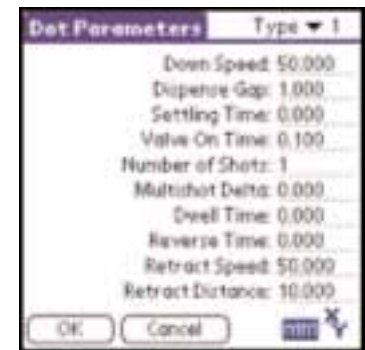

Dispense Gap

The Dispense Gap is the distance between the substrate you are dispensing on and the needle tip. This distance is one of the more common adjustments to optimize dispensing programs. Typically, the Dispense Gap is set to half the dot diameter.

The height sensor affects the dispense gap setting. This parameter is active only when the tip-to-probe offset has been set and a Height Sense instruction is inserted in the program.

Settling Time

This is the length of time that the dispensing head will wait over the dispensing location before beginning to dispense. The Settling Time is set to 0, except in special circumstances. For more information, contact your local EFD representative.

Valve-On Time

This parameter controls the time the valve is opened while positioned over the dispensing location. The time interval affects dot size, i.e. the longer the Valve-On Time, the larger the dot. The units are in seconds.

The Valve-On time can be as long as 60 seconds, depending on the desired dot size and fluid properties. You can elect to dispense multiple shots if your desired deposit size takes longer than 60 seconds to achieve.

Number of Shots

This parameter controls how many shots of fluid will be dispensed at a single location. When making a larger dot with multiple shots, it is desirable to move the needle up between shots. The default setting is 1.

Multishot Delta

This is the Z-height that the dispensing head will retract between each shot at the same X/Y location. It is used in conjunction with Number of Shots. Note that the Dwell Time parameter is applied between shots. The units are in inches or millimeters.

In a potting application, the use of the Number of Shots and Multi-Shot Delta keep the dispense tip above the potting compound as part is being filled.

Dwell Time

Dwell Time measures how long the dispensing head stays at the final position after the end of dispensing before retracting multishot delta. This may be necessary to give the fluid a chance to detach from the tip and onto the substrate i.e. increasing the Dwell Time can reduce "stringing" of material. The units are in seconds.

For most solder pastes and adhesives, 30 ms is sufficient. However, the Dwell Time can be set as long as 6 seconds for very elastic fluids.

Reverse Time

This parameter is only required when the 790 Auger valve has been selected in the Setup mode. At the end of dispensing a dot, the valve is reversed for the specified time period to remove any material from the tip of the needle. The Reverse Time value should be set according to fluid/paste viscosity. Generally, 10 ms (0.010 sec) is sufficient.

Retract Speed

This is the speed of the dispensing head while moving the Retract Distance (valve moving up). This parameter is useful in breaking off stringing material i.e. slowing retract speed. The units are either in inches/second or mm/second. Typically, 2 in/sec or 50.8mm/sec is sufficient.

Retract Distance

This is a vertical distance that the dispensing head moves after dispensing. The Retract Distance must be high enough to clear any obstacles on the work-piece during the movement to the next point. The Retract Distance can be reduced to increase throughput. The units are either in inches or millimeters. Typically, 10mm or 0.4 in is sufficient.

APPENDIX E

Line Parameters Explained

Line parameters control the different aspects of a line dispense command. They need to be set prior to teaching the end of a continuous path movement including the ARC and CIRCLE instructions. Although the program already has default settings, it is highly recommended that the User Operator review and set each Line Parameter to obtain the desired application results.

Note that each program can be configured for up to 10 different line types, and each time-related line parameter is limited to a maximum of 65.535 seconds.

Down Speed

The Down Speed measures how fast the dispensing head lowers to dispense. The units are in inches/sec or mm/sec. Typically, 2 in/sec or 50.8mm/sec is sufficient.

Dispense Gap

The Dispense Gap is the distance between the needle tip and the substrate during dispensing operations. This distance is one of the more common adjustments made to optimize a dispensing program.

Note: dispense gap is only used after a height sense is inserted in a program.

Otherwise, the machine will move to taught Z-position. The units are in either inches or millimeters. Typically 15 - 20 mils (0.015 - 0.020 in) is sufficient.

Pre-Move Delay

Higher-viscosity fluids do not dispense as quickly as lower-viscosity fluids. The Pre-Move Delay parameter increases the time that the dispensing head is parked with the valve ON, prior to a programmed move. The delay at the beginning position insures that a full line is dispensed. The units are in seconds. Typically, 50 ms (0.050 sec) is sufficient for most fluids.

Line Speed

This refers to how fast the dispensing head moves during dispensing. This parameter controls the bead diameter within a given flow rate. The speed of the dispensing head affects the amount of fluid dispensed.

The units are in inches/second or mm/second. Typical dispense speeds range from 1.0 – 4.0 inches/second (or 25.4 – 101.6 mm/second), depending upon fluid flow rates and path trajectory.

Shutoff Distance

This parameter controls the point where the valve stops dispensing before the end of the move. Post-extrusion often is affected by tip size, fluid pressure and material viscosity. Hence, if any changes are made to these factors mid-stream, it is likely that Shutoff Distance will need to be readjusted.

Note: The shutoff distance cannot be longer than the last line segment e.g. CP Mid to CP End.

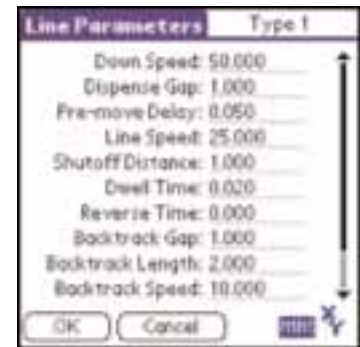



Dwell Time

Dwell Time measures how long the dispensing head stays at the final position after the end of dispensing before retracting. This may be necessary to give the fluid a chance to detach from the tip and onto the substrate, i.e. increasing the Dwell Time can reduce “stringing” of material.

The units are in seconds. Typically, 0 - 20 ms (0.020 sec) is sufficient.

Reverse Time

This parameter is only required when the 790 Auger Valve has been selected in the Setup mode. At the end of dispensing a dot, the valve is reversed for the specified time period to remove any material from the tip of the needle. The Reverse Time value should be set according to fluid/paste viscosity. Generally, 10 ms (0.010 sec) is sufficient.

Backtrack Gap

This is the vertical distance that the dispensing head moves up after completion of a move. At the end of a move, the dispensing head is raised up by the amount set in the Backtrack Gap, before moving the Backtrack Length back over the line that was just dispensed. This encourages congealed fluids to detach and distributes any excess fluid back across the line.

The units are either in inches or millimeters. Backtrack Gap should be at least double the Dispense Gap.

Backtrack Length

This is the horizontal distance the dispensing head moves back over the dispensed line after raising up the Backtrack Gap distance. This encourages congealed fluids to detach and distributes any excess fluid back across the line.

The units are in inches or millimeters. Typically, 30 - 40 mils (0.030 - 0.040 in) is sufficient.

Backtrack length can be negative. This will force the movement of the tip to move forward in the same direction as the line, instead of backwards over the line. This can be useful when dispensing a closed path, such as a square or circle.

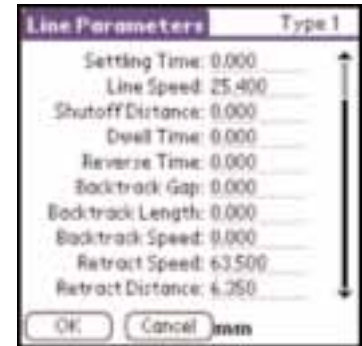

Backtrack Speed

This is the speed the dispensing head travels at when moving along the Backtrack Length. The units are either in inches/second or mm/second. Typically, 2 in/sec or 50.8mm/sec is sufficient.

Retract Speed

This is the speed of the dispensing head while moving the Retract Distance. The units are in either inches/second or mm/second. Typically, 2 in/sec or 50.8mm/sec is sufficient.

Retract Distance

This is a vertical distance that the dispensing head moves after the Backtrack Gap and Backtrack Length dispensing commands are completed. The figure below shows the relationship between Retract Distance, Backtrack Gap and Backtrack Length.

The Retract Distance must be set high enough so the machine can move safely to the next point without hitting any obstruction on the work piece.

The units are in either inches or millimeters. Typically, 30 mils (0.030 in or 0.762mm) is sufficient.

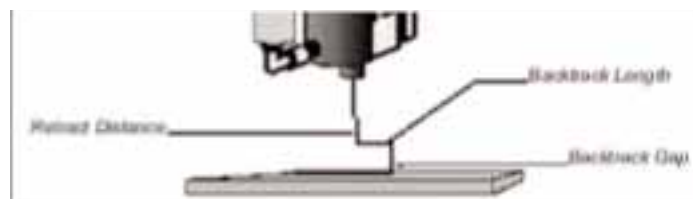

APPENDIX F

Technical Support Request Form

Also available at <http://www.efd-inc.com/xyz/technical-form.html>

Date: _____

Requester: _____

Location: _____

Company: _____

About the Unit

Serial Number: _____

Model Number: _____

Firmware Version: _____

Software Version: _____

Type of PDA Used (indicate model): Palm _____ / Sony _____

PDA to TT interface: Cable / RS232 / Bluetooth

Baud rate setting: Main Board _____ PDA Software _____

Has the personality parameter of the machine
been changed from factory setting? Yes / No

Application

Bracket Used: Single / Dual / Triple / Custom

Valve Used: EFD _____ / Other _____

Weight of bracket/valve on Z-axis: _____ kg

Weight of fixture/part on X-axis: _____ kg

Describe the application:

Problem Encountered

Description of the problem

Error code on PDA: _____

Error code on LCD panel: _____

Describe what steps have been taken to resolve the problem:

Is a copy of the application program attached? Yes / No

GLOSSARY OF TERMS

Fiducial

A point of reference designed into a part or fixture that can be used to determine part or workpiece shift. This point is often used as the "Origin" point in a program.

Jogging

Refers to moving the Ultra TT series axes to teach either points or offsets. Jogging is accomplished by using the hard keys on the Palm handheld, the compass rose or blue field in the Jog window, and the front panel arrow buttons.

Mechanical Home

This is when all axes have returned to their travel origination points. This is determined by the location of the homing sensors. The Ultra TT is at mechanical home when the Z-axis is all the way up, X-axis is all the way to the left most position and the Y-axis is all the way to the back of the machine.

Dispensing Tip Offsets

This refers to the delta (change) in X/Y/Z of the dispensing tip when the tip has been removed and replaced with a new one. It is important that you teach the new tip position so the Ultra TT can accurately dispense your fluid.

Soft Key

Soft keys are software dependent and are designated by a highlighted function for the dome switch immediately below the command on the LCD Screen located on the front panel.

Current

Defined as flow from the positive terminal of the power supply to the negative terminal.

Ground

The negative terminal of the power supply

Driver

Controls the current in another electronic circuit (the load). A driver is considered to be ON when it allows current to flow in its load. A driver is considered to be OFF when it does not allow current to flow in its load. A driver may be a bipolar transistor or a Field Effect transistor. Opto-isolated devices are preferred. A driver may also be a mechanical switch or, preferably, an isolated relay contact.

Load

Any component or arrangement of several components that conducts current, when a driver is placed in an "ON" condition. The input circuitry of the Ultra TT is considered to be a load for external driver circuitry. The input circuits of external circuitry are considered to be loads for the output drivers of the Ultra TT.