

Operating Guide

Model 800 Dispenser

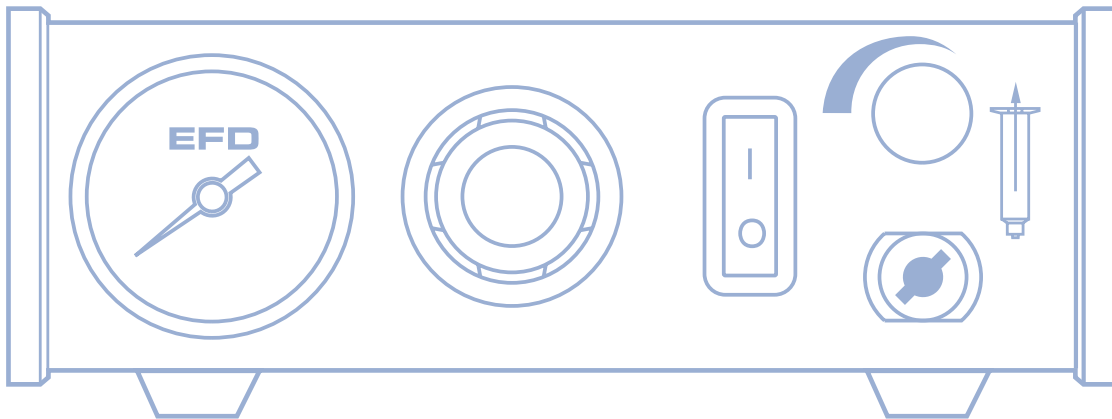

Introduction

Model 800 fluid dispenser provides years of trouble-free, productive service. This Operating Guide will help you maximize the usefulness of your new dispenser.

Please spend a few minutes to become familiar with the controls and features of your new dispenser. Follow our recommended testing procedures. Review the helpful information we have included based on over 30 years of industrial dispensing experience.

Most questions you will have are answered in this Guide. However, if you need assistance, please do not hesitate to contact EFD or your authorized EFD distributor.



In the US, call 800-556-3484.

In Mexico, call 001-800-556-3484.

In the UK, ring free 0800 585733.

The EFD Pledge

We pledge that you will be completely satisfied with our products. We endeavor to ensure that every EFD product is produced to our no-compromise quality standards.

If you feel that you are not receiving all the support you require, or if you have any questions or comments, I invite you to write or call me personally.

Our goal is to build not only the finest equipment and components, but also to build long-term customer relationships founded on superb quality, service, value and trust. Randall Richardson, President

Model 800 Specifications

Input voltage: Selectable
100/120/220 VAC 50/60Hz 26/20 VA

Air input: 80 to 100 psi (5.5 to 6.9 bar)

Internal voltage: 24 VAC

Foot pedal voltage: 24 VAC

800

7¼ x 8½ x 2⅝" 3 lb 4 oz
(18.4 x 21.6 x 6.7 cm) (1.48 kg)

Air output: 0 to 100 psi (0 to 7.0 bar)

First Steps

Contents

Dispenser Hookup	4-5
Controls & Connections	6
Setup for Testing	7
Testing the Dispenser	8
Using the Vacuum Control	9
ULTRA Dispensing System	10-11
Loading the Barrel Reservoirs	12-13
Suggestions & Reminders	14
Components Reorder	15
Two Year Limited Warranty	16

Meets applicable CSA and CE requirements.

Reference CSA LR File Number 84105

This manual is for the express and sole use of EFD dispenser purchasers and users, and no portion of this manual may be reproduced in any form. EFD, ULTRA System, LV Barrier, SmoothFlow, ZeroDraft, SafetyLok, SnapLok and DispenStand are trademarks of EFD Inc. ©2001 EFD Inc.

First: Unpack and use the checklist enclosed with the Dispenser Kit to identify all items. If there is any discrepancy, please call us immediately.

Second: Power and compressed plant air should be available where the dispenser is to be set up. Air pressure should be between 80 and 100 psi (5.5 and 6.9 bar). If you are not using an EFD five-micron filter regulator #2000F755, **be certain your plant air is properly filtered and dry.**

Bottled nitrogen can be used.

Warning: If high pressure bottled air or nitrogen is used, a high pressure regulator must be installed on the bottle and set up at 100 psi maximum. The #2000F755 filter regulator is not required.

Check the voltage label to be certain it is set to the available power.

Third: Now is a good time to **ACTIVATE** your extended Two Year Limited Warranty. Please fill in and return the postage paid Warranty card. Or if you prefer, call the appropriate toll-free number listed below, provide the serial number of your dispenser and respond to a few short questions. You are then assured of complete protection for two years.



US, call 800-556-3484.

In Mexico, call 001-800-556-3484.

In the UK, ring free 0800 585733.

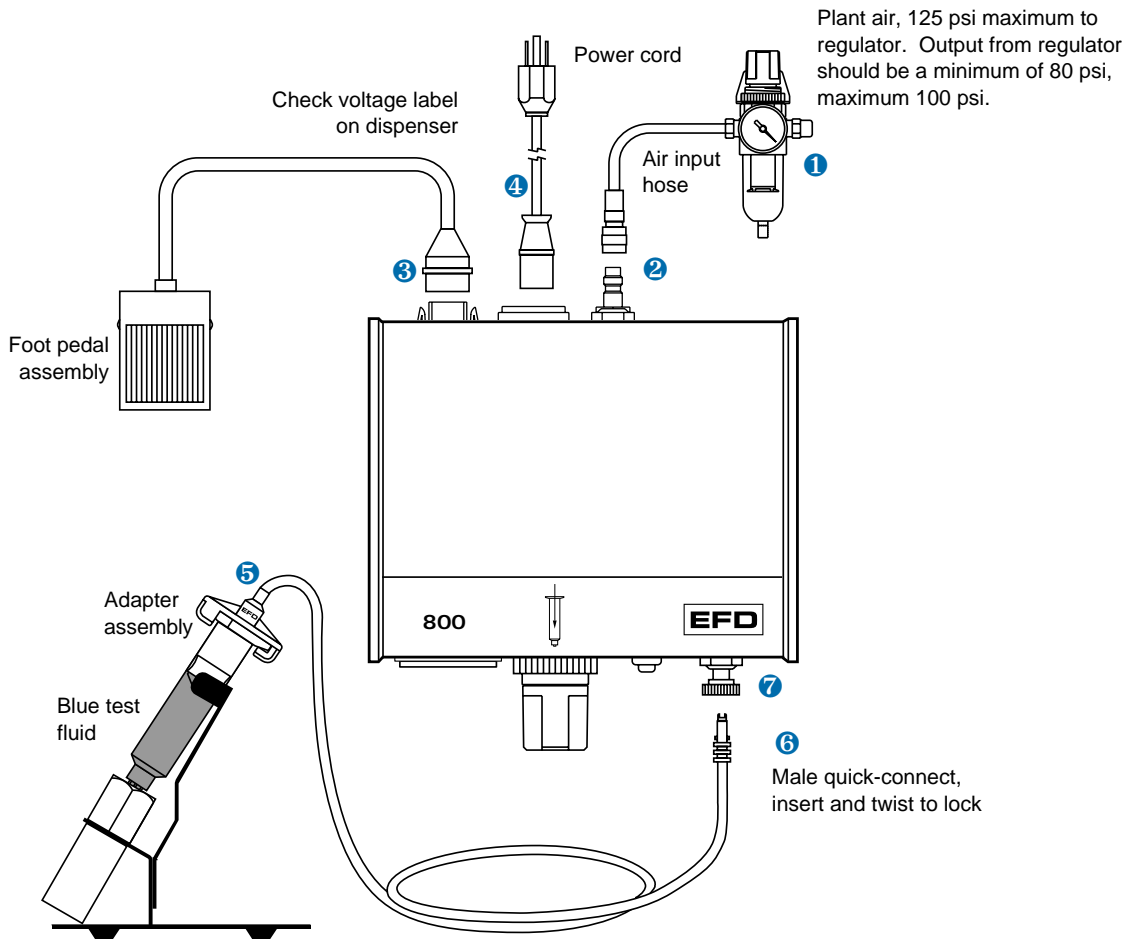

Dispenser Hookup

- 1 Connect the air input hose to a plant air source. Set plant air supply within 80 to 100 psi (5.5 to 6.9 bar). Where required, use an EFD five-micron filter regulator #2000F755 (see Warranty).
- 2 Attach the air input hose coupling to the dispenser. Pull back metal ring to attach to dispenser.
- 3 Plug in the polarized, foot pedal connector.
- 4 Check the voltage label on the input voltage selector cartridge. To change the voltage, remove the voltage selector from the cartridge, rotate it and position the correct voltage to show through the cartridge window. Replace the cartridge into the power cord receptacle and insure that both sides snap securely into position.

Install the power cord.

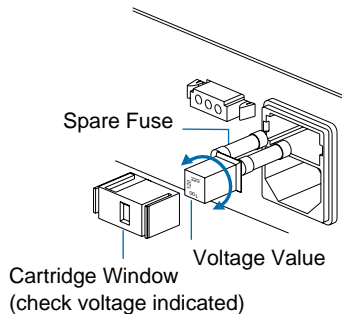

Note: The dispenser is shipped with the fuse cartridge set for 120 VAC input.

- 5 Attach the 10cc barrel prefilled with blue, nontoxic test fluid (included with the dispenser) to the 10cc adapter head.

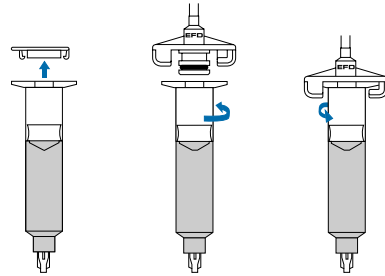

- 6 Take the 10cc barrel adapter assembly (#5150 on the adapter head) and insert the black, male quick-connect into the air output fitting on the front panel and turn clockwise to lock. Place the barrel in the barrel stand.
- 7 During the initial testing, you will not use the vacuum control. Keep this control shutoff (turned completely clockwise—do not force).

Controls & Connections

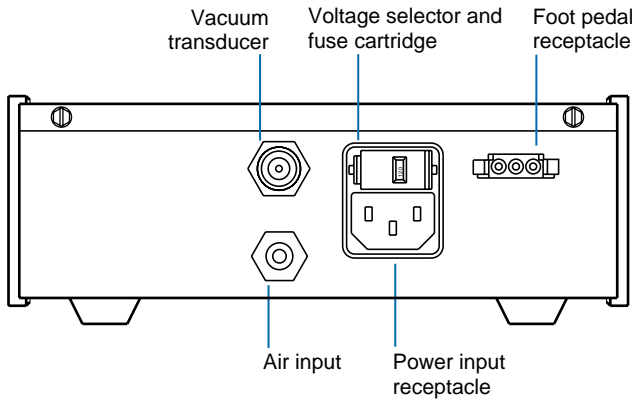
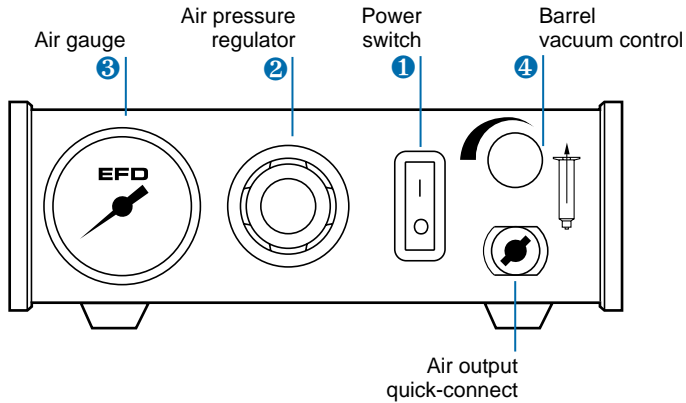

Setup for Testing

Power switch ❶ should be off.

The amount of material dispensed each cycle depends on the combination of air pressure, viscosity of material, dispensing tip size and the length of time the foot pedal is pressed.

The first step is to remove the tip cap from the prefilled barrel of blue test material (twist and pull). Replace it with an 18 gage (green) tapered dispensing tip. Press the tip on and twist clockwise to lock.

Pull out air pressure regulator knob ❷ until it "clicks" into the unlocked position. Turn clockwise to adjust the air pressure to 10 psi (0.7 bar) for the initial tests.

Always set the pressure desired by turning the air regulator knob ❷ clockwise. To reduce the pressure, turn the knob counterclockwise until the air gauge ❸ reads a lower pressure than desired. Then increase and stop at desired pressure. Push knob in to lock.

Be sure barrel vacuum control ❹ is turned off (turn clockwise) for initial tests.

Press power switch ❶ to turn on the dispenser. It will light green.

Please continue to page 8 for test procedures.

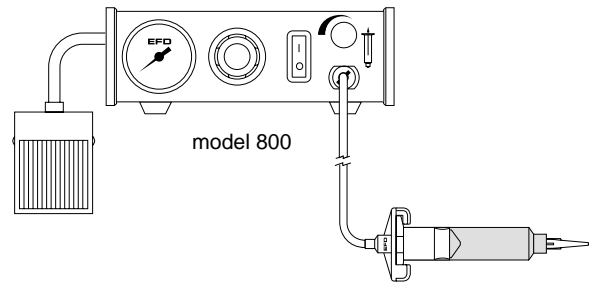

Testing the Dispenser

You are now ready to test the dispenser using the prefilled barrel of blue, nontoxic test material.

Begin with the following settings:

	Thick fluid (blue)	Thin fluid (clear)
Air gauge	10 psi (0.7 bar)	5 psi (0.4 bar)
Dispense tip	18 gage (green)	25 gage (red)
Vacuum control	Off	On (see page 9)

Press the power switch on. It will light green.

Holding the barrel as shown, rest the tip on a piece of paper. Press the foot pedal until the tip fills and some fluid is pushed out onto the paper. (Repeat this whenever you change to a new tip.)

Use the Dot Test Sheet supplied, and press the foot pedal to make a dot or stripe. Make several more deposits, carefully applying the tip at the angle shown and removing the tip as shown.

Remember - always bring the tip in contact with the work surface at the illustrated angle. After the tip is in position, press the foot pedal. A continuous flow of material will occur as long as the foot pedal is pressed.

Try different pressure settings. Continue to experiment by replacing the green tip with the blue (22 gage) tapered tip included in the Dot Test Kit. Note the effects of air pressure and tip size on the deposit.

Adjusting the Deposit Amount

The deposit size is determined by the tip diameter, the output air pressure setting and the length of time the foot pedal is pressed.

To increase the deposit size, slightly increase output air pressure, or increase tip size, or both. To decrease the deposit amount, use a smaller tip size, or lower the air pressure.

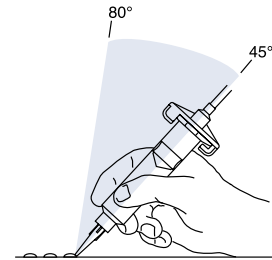

Correct angle for making deposits.

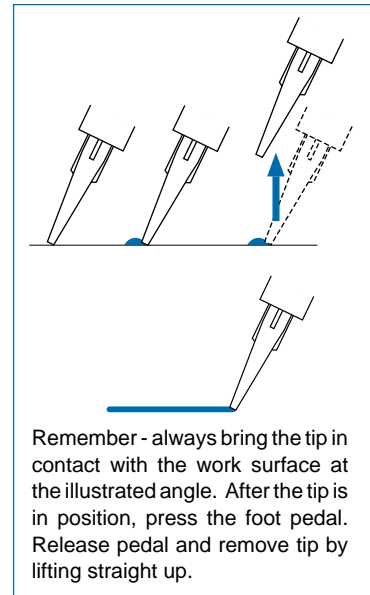

Remember - always bring the tip in contact with the work surface at the illustrated angle. After the tip is in position, press the foot pedal. Release pedal and remove tip by lifting straight up.

Using the Vacuum Control

The vacuum control allows low viscosity fluids, even water, to be consistently dispensed without dripping between cycles. The vacuum exerts a negative pressure on the fluid in the barrel and prevents dripping.

For these tests, you will use the test barrel with the clear fluid.

1. While holding the barrel upright in one hand, remove the orange end cap and insert the white SmoothFlow™ piston. Carefully press the piston down until it contacts the fluid.

Be sure to push it far enough to remove all air, but **not** into the fluid, since this will force the fluid up along the sides of the piston.

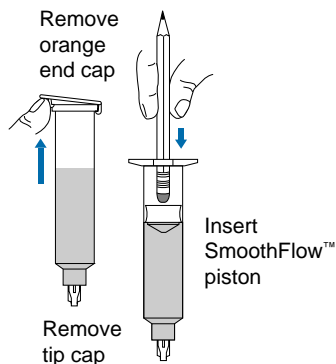

2. Attach the barrel to the yellow adapter head. Snap the safety clip tightly closed to prevent any dripping or bubbling. Remove the tip cap and attach the 25 gauge (red) tip.
3. Set air pressure at 5 psi (0.4 bar).
4. With the barrel pointing downward over a container, press the foot pedal to fill the tip.

5. If a drop begins to form at the end of the tip, slowly turn the vacuum control knob counter-clockwise to stop the drop from growing. Wipe the tip and slowly adjust vacuum as necessary.
6. Take the barrel and place the tip on the Dot Test Sheet. Press the foot pedal and release. Check the deposit. You control the fluid flow

Regardless of the viscosity of the fluid you use, you should try using the SmoothFlow™ piston (see pages 10-11).

If you choose **not** to use the piston, please read the following points. rate by increasing the air pressure output (higher flow) or decreasing the air pressure output.

Three things to remember

If you do not use the piston when dispensing thin fluids:

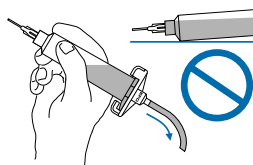

Do not tip the barrel upside down or lay flat. This will cause the fluid to run into the dispenser.

Open



When changing tips or attaching a tip cap, snap the safety clip completely closed to prevent any dripping or bubbling.



Closed

Use an EFD filter trap (#1000FLT-Y). This filter trap will impede the flow should the low viscosity fluid be sucked back towards the dispenser.

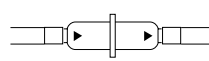



Advanced Dispensing System

If you dispense thick fluids, several problems may occur. First, the repetitive air cycles can bore tunnels through non-leveling fluids, causing spitting and inconsistent deposits. Second, thick fluids contain trapped air that leads to drooling and oozing.

These problems are eliminated by using the SmoothFlow™ piston. That's because the white pistons prevent tunneling by providing a barrier to the pulsed-air cycles, and prevent oozing by responding to the pressure of trapped air with a slight suck-back movement after the dispense cycle.

The white piston is used for most fluids.

However, if you are applying RTV silicone and find that the piston bounces and causes stringing, switch to the orange, flat wall piston.

The SmoothFlow™ pistons make barrel filling easier, too. As you load the fluid in, air is trapped in the bottom and throughout the fluid. Simply insert a SmoothFlow™ piston and gently press down on the fluid as far as possible. This action forces out most of the air and results in consistent deposits.

For Thick Fluids

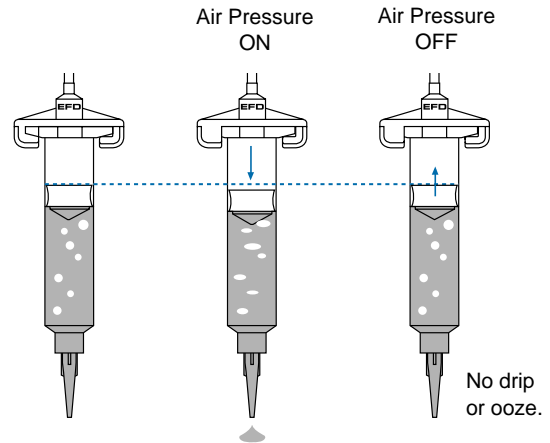

If you use low to medium viscosity fluids, the white SmoothFlow™ piston has several advantages.

First, vacuum adjustment is much less sensitive. Second, the piston prevents fumes from the fluid being exhausted into the work environment. Third, the piston prevents fluid backflow into the dispenser if the barrel is inadvertently turned upside down. Fourth, using the piston makes it easy and safe to change tips without dripping.

Note: If you use watery-thin fluids such as solvents, cyanoacrylates and anaerobics, specify the ULTRA System™ with the blue LV Barrier™. Available in 3cc and 10cc sizes.

For Cyanoacrylates or Watery-thin Fluids

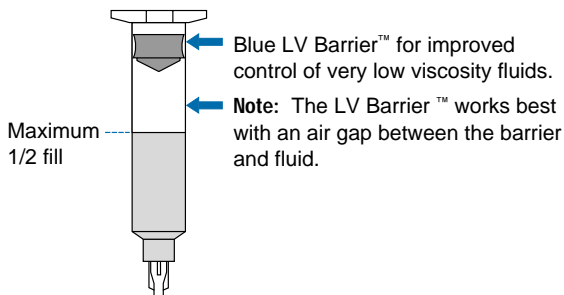

For Thinner Fluids

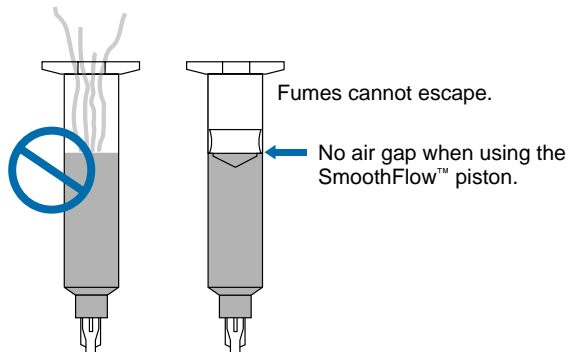
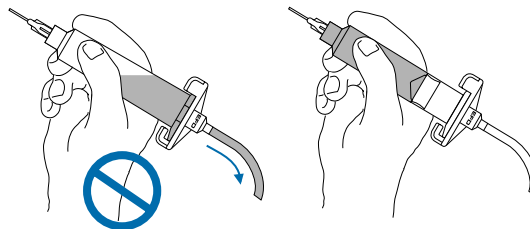

Note: If you choose not to use the piston, please refer to page 9 for instructions.

Loading the Barrel Reservoirs

Caution: Do not completely fill barrels. The optimum fill is a maximum $\frac{2}{3}$ of the barrel capacity and $\frac{1}{2}$ of the barrel capacity when using the LV Barrier™.

If the fluid you are dispensing is pourable, take the barrel, twist on a tip cap and pour your fluid in. If appropriate, insert the SmoothFlow™ piston (see pages 10-11). Carefully press the piston down until it contacts the fluid. The barrel is now ready for use.

If you are dispensing watery solvents, cyanoacrylates or anaerobics, use the LV Barrier™. Place barrier in the top of the barrel reservoir. Allow air between barrier and fluid. Do not contact the barrier to the fluid.

If your fluid is thick or non-leveling, you can spoon it into the barrel with a spatula. Or, if the fluid comes packed in a 1/10 gallon cartridge, try loading the barrel with a caulking gun. Then press in the SmoothFlow™ piston to move the fluid to the bottom of the barrel and to remove trapped air.

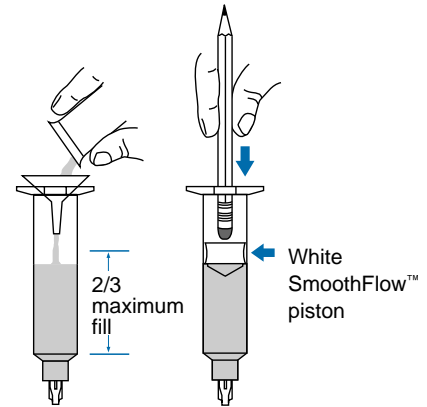

Fill procedure for pourable fluids

Fill procedure for thick fluids (shown: caulking gun)

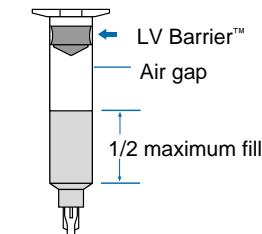
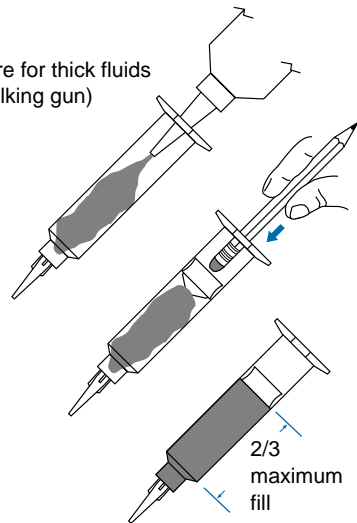

Fill procedure for cyanoacrylates or watery-thin fluids

EFD offers productive alternatives to traditional barrel-loading methods. Here are a few suggestions that can help keep your work area clean, save time and reduce the chance of entrapped air in the fluid.

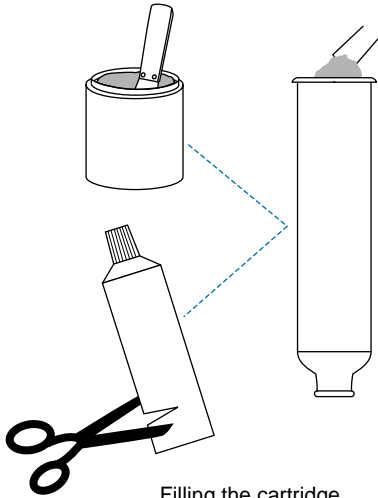

Filling the cartridge for the barrel loader.

1. You could use the EFD #920BL barrel loader. Pack the fluid into the 12 ounce cartridge as shown. Then place the pre-filled cartridge into the barrel loader. Using air pressure, the barrel loader fills the barrel (with piston) from the bottom up.

If the fluid comes packed in a 1/10 gallon (300 ml.) caulking type cartridge, use the EFD #940BL barrel loader.

2. If you receive frozen epoxies or other fluids in medical type syringes with a manual plunger, ask your fluid packager to use EFD industrial grade barrels, or request our luer-to-luer fitting #2160 to transfer the material.

Please call an EFD Fluid Application Specialist for additional assistance.

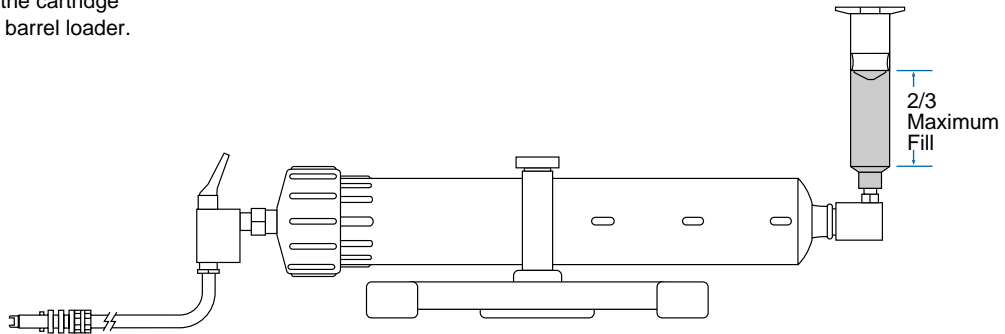

EFD #920BL Barrel Loader
(Specify #940BL for pre-filled 1/10 gallon caulking tubes)

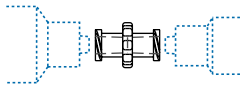

#2160 Luer-to-luer fitting

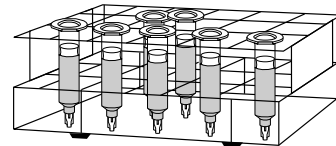

Barrel Rack
#905BR holds (72) 3cc and 5cc barrels
#910BR holds (24) 10cc, 30cc and 55cc barrels

Suggestions & Reminders

1. Always use an EFD piston to make your barrel loading, dispensing and handling cleaner, safer and more accurate.

Caution: If you dispense watery-thin fluids and choose **not** to use SmoothFlow™ pistons – do not increase vacuum pressure rapidly and do **not** tip the barrel. Vacuum may pull liquid into the air hose; or when tipped, liquid may flow back into the dispenser.

2. Always use new barrels and tips. Carefully dispose of after use. This procedure ensures maximum cleanliness, prevents contamination and provides proper safety.
3. Do not completely fill the barrel. For most fluids, optimum fill is a maximum 2/3 of the barrel capacity. For cyanoacrylates or watery-thin fluids, optimum fill is 1/2 of the barrel capacity.
4. Use the EFD #DS1200 DispenStand™ to help organize bench space. Adapter hose support keeps hose off of the work area. See illustration.
5. Depending on the type of work you are doing, it may be easier to bring the work to the barrel. Mount the barrel on a stand such as the EFD #7300A.
6. To ensure smooth fluid flow and to make consistent deposits, always have the tip at about a 45° angle to the work surface.

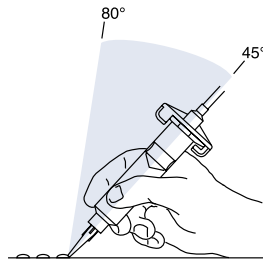
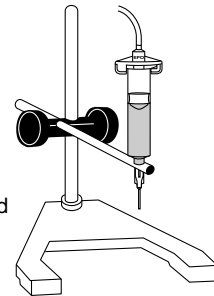
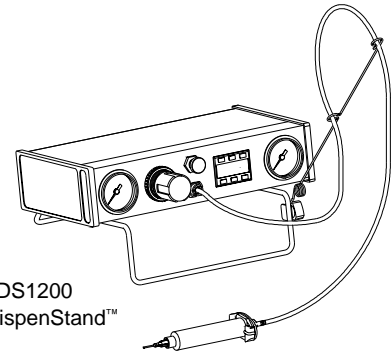

ULTRA System™ Dispensing Components

For complete selection and technical details, please refer to EFD Catalog and price list.

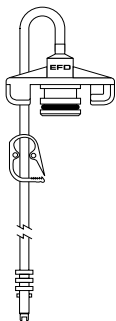

Barrel adapter assemblies

Molded one-piece, yellow, SnapLok™ adapter head with Buna N O-ring, flexible 5/32" O.D. hose, male quick-connect and safety clip.

size	with 3-ft hose	with 6-ft hose
3cc	1000Y5148	1000Y5148-6
5cc	1000Y5149	1000Y5149-6
10cc	1000Y5150	1000Y5150-6
30cc/55cc	1000Y5152	1000Y5152-6

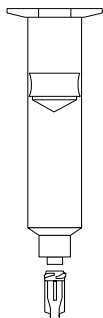

Each box contains the same quantity of barrels and pistons.

size	clear	UV-block	opaque	sets/ box
		amber	black	
3cc	5109CP-B	5109AP-B	5109UP-B	50
5cc	5110CP-B	5110AP-B	5110UP-B	40
10cc	5111CP-B	5111AP-B	5111UP-B	30
30cc	5112CP-B	5112AP-B	5112UP-B	20
55cc	5113CP-B	5113AP-B	n/a	15



Smooth-flow tapered tips

Molded polyethylene with UV block. Packaged (50) tips per see-through box for easy part identification.

gage	ID	tapered	color
14	.063"	5114TT-B	olive
16	.047"	5116TT-B	grey
18	.033"	5118TT-B	green
20	.023"	5120TT-B	pink
22	.016"	5122TT-B	blue
25	.010"	5125TT-B	red

General purpose precision tips

All EFD dispensing tips incorporate the unique SafetyLok™ color-coded polypropylene hubs. Conveniently packaged (50) tips per see-through box for easy part identification.

gage	ID	1/2" length	hub color
14	.061"	5114-B	olive
15	.054"	5115-B	amber
18	.033"	5118-B	green
20	.024"	5120-B	pink
21	.020"	5121-B	purple
22	.016"	5122-B	blue
23	.013"	5123-B	orange
25	.010"	5125-B	red
27	.008"	5127-B	clear
30	.006"	5130-B	lavender



Useful accessories

#2000F755: Five micron filter regulator provides proper air filtering for all dispensers. Order if you do not have dry, clean, filtered factory air supply.



2000F755

#7300A: Barrel stand, fully adjustable three axes.

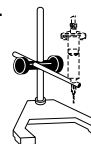

7300A

#DS1200: Horizontal stand tilts dispenser at a 14° angle for convenient viewing and operation.

#DS1400: DispenStand™ holds dispenser vertically.

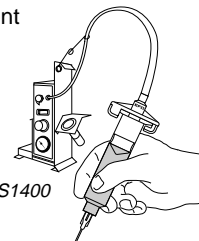

DS1400

EFD Two Year Limited Warranty

All components of EFD dispensers are warranted to the original end user for two years from date of purchase.

Within the period of this warranty, EFD will repair or replace free of charge any defective component on return of the part, or the complete dispenser, prepaid to the factory.

In no event shall any liability or obligation of EFD arising from this warranty exceed the purchase price of the equipment. Before using, user shall determine the suitability of the product for his intended use, and user assumes all risk and liability whatsoever in connection therewith. This warranty is valid only when clean, dry, filtered air is used.

EFD makes no warranty whatsoever of merchantability or fitness for a particular purpose. In no event shall EFD be liable for incidental or consequential damages.



Headquarters: 977 Waterman Avenue, East Providence, RI 02914-1378 USA
US & Canada: 800-556-3484 Mexico: 001-800-556-3484
Telephone: 401-434-1680 Fax: 401- 431-0237
E-mail: technical@efd-inc.com www.efd-inc.com

Unit 14, Apex Business Centre, Boscombe Road
Dunstable, Bedfordshire LU5 4SB UK
Telephone: 01582 666334 Fax: 01582 664227
Freephone: 0800 585733 From Ireland: 00800 8272 9444
E-mail: sales@efd.co.uk www.efd.co.uk



Printed on
recycled paper